

MIKOM

MV Series Servo Drive User Manual

V1.2



MIKOM Electrical Technology Co.,Ltd.

Preface

Thank you for purchasing the MV series AC servo drive developed by Weihai MIKOM Electrical Technology Co., Ltd.

The MV series AC servo drive is a general-purpose high-performance vector control AC servo drive. It can implement the control of asynchronous motor and permanent magnet synchronous motor (PMSM). It increases the user programmable function, background monitoring software and communication bus function, and supports multi-kind PG cards. It is used to servo drive various automation production equipment involving textile, paper-making, wire drawing, machine tool, packing, food, fan and pump.

This manual describes the correct use of the MV series AC servo drive, including selection, parameter setting, commissioning, maintenance & inspection. Read and understand the manual before use and forward the manual to the end user.

Servo drive is precision electronic products, for first-time users of this product, should read this manual carefully. When you happen any problems in use and can't help you with the solution of this manual, please relate our local agent or directly contact with our company, our professional and technical personnel will be positive to serve you.

Product Checking

Upon unpacking, check:

- Whether the nameplate model and AC servo drive ratings are consistent with your order. The box contains the AC servo drive, certificate of conformity, user manual and warranty card.
- Whether the AC servo drive is damaged during transportation. If you find any omission or damage, contact Inovance or your supplier immediately.

Catalogue

Chapter 1	Safety Information.....	1
1.1	Safety Information	1
1.2	Servo drive scrap matters needing attention	3
Chapter 2	Product Specifications.....	4
2.1	Model Code	4
2.1.1	Explanation to nameplate	4
2.1.2	Series Description.....	4
2.2	Technical Specifications	4
2.3	Servo drive model and adaptation motor	7
2.4	Servo drive parts name.....	8
Chapter 3	Wiring Installation.....	9
3.1	Servo drive overall dimensions.....	9
3.2	Operation panel size.....	11
3.3	The installation of the servo drive	11
3.3.1	Installation of interval and distance	11
3.3.2	Disassembly and installation of the servo drive	12
3.3.3	Remove the front cover of the servo drive	12
3.4	Description of Main Circuit wiring and Terminals.....	13
3.4.1	Single/three phase less than or equal to 2.2KW servo drive terminals	13
3.4.2	Three phase more than or equal to 4KW servo drive terminals	13
3.4.3	The servo drive system main circuit terminal wiring and grounding	14
3.4.4	The servo drive and motor wiring diagram and the matters needing attention.....	16
3.5	The servo drive control circuit wiring and terminals.....	16
3.5.1	Single/three phase less than or equal to 2.2 KW servo drive terminals	16
3.5.2	Single/three phase more than or equal to 2.2 KW servo drive terminals	18
3.5.3	Communication wiring.....	20
3.5.4	Analog input wiring.....	21
3.5.5	Analog output wiring	22
3.5.6	Switch input and wiring	22
3.5.7	Switch output wiring	23
3.5.8	High-speed pulse output port Y2 / DO, input port X8 / DI	23
3.5.9	Relay output wiring	24
3.6	The MV series servo drive system configuration scheme.....	24
Chapter 4	The operation of the keyboard.....	26
4.1	Operation panel is introduced.....	26
4.2	Indicator light show	26
4.3	The LED display area	26
4.4	Introduction to run or stop display parameters.....	27
4.5	Operation panel button is introduced.....	28

4.6	The operation panel display status	28
4.7	Keyboard	29
Chapter 5	For the first time on electricity to run.....	32
Chapter6	Function parameter profiles	34
Chapter 7	Common symbols display and fault alarm processing methods.....	90
7.1	Common display symbols causes and treatment	90
7.2	Fault alarm and processing method	91
7.3	Common fault alarm and processing methods	99
Chapter 8	Maintenance and maintenance	102
8.1	Daily maintenance	102
8.2	Regular inspection	102

Chapter 1 Safety Information

1.1 Safety Information

In this manual, the notices are graded based on the degree of danger:















indicates that failure to comply with the notice will result in severe personal injury or even death.



indicates that failure to comply with the notice will result in personal injury or property damage.

Read this manual carefully so that you have a thorough understanding. Installation, commissioning or maintenance may be performed in conjunction with this chapter. Inovance will assume no liability or responsibility for any injury or loss caused by improper operation.

Use	Safety Grade	Precautions
Before installation	 Danger	<ul style="list-style-type: none"> ◆ Do not install the equipment if you find water seepage, component missing or damage upon unpacking. ◆ Do not install the equipment if the packing list does not conform to the product you received.
	 Warning	<ul style="list-style-type: none"> ◆ Handle the equipment with care during transportation to prevent damage to the equipment. ◆ Do not use the equipment if any component is damaged or missing. Failure to comply will result in personal injury. ◆ Do not touch the components with your hands. Failure to comply will result in static electricity damage.
During installation	 Danger	<ul style="list-style-type: none"> ◆ Install the equipment on incombustible objects such as metal, and keep it away from combustible materials. Failure to comply may result in a fire. ◆ Do not loosen the fixed screws of the components, especially the screws with red mark.
	 Warning	<ul style="list-style-type: none"> ◆ Do not drop wire end or screw into the AC servo drive. Failure to comply will result in damage to the AC servo drive. ◆ Install the AC servo drive in places free of vibration and direct sunlight. ◆ When two AC drives are laid in the same cabinet, arrange the installation positions properly to ensure the cooling effect.
At wiring	 Danger	<ul style="list-style-type: none"> ◆ Wiring must be performed only by qualified personnel under instructions described in this manual. Failure to comply may result in unexpected accidents. ◆ A circuit breaker must be used to isolate the power supply and the AC servo drive. Failure to comply may result in a fire. ◆ Ensure that the power supply is cut off before wiring. Failure to comply may result in electric shock. ◆ Tie the AC servo drive to ground properly by standard. Failure to comply may result in electric shock.
	 Warning	<ul style="list-style-type: none"> ◆ Never connect the power cables to the output terminals (U, V, W) of the AC servo drive. Pay attention to the marks of the wiring terminals and ensure correct wiring. Failure to comply will result in damage to the AC servo drive.

Use	Safety Grade	Precautions
		<ul style="list-style-type: none"> ◆ Never connect the braking resistor between the DC bus terminals (+) and (-). Failure to comply may result in a fire. ◆ Use wire sizes recommended in the manual. Failure to comply may result in accidents. ◆ Use a shielded cable for the encoder, and ensure that the shielding layer is reliably grounded.
Before power-on	 Danger	<ul style="list-style-type: none"> ◆ Check that the following requirements are met: <ul style="list-style-type: none"> – The voltage class of the power supply is consistent with the rated voltage class of the AC servo drive. – The input terminals (R, S, T) and output terminals (U, V, W) are properly connected. – No short-circuit exists in the peripheral circuit. – The wiring is secured. Failure to comply will result in damage to the AC servo drive ◆ Do not perform the voltage resistance test on any part of the AC servo drive because such test has been done in the factory. Failure to comply will result in accidents.
	 Warning	<ul style="list-style-type: none"> ◆ Cover the AC servo drive properly before power-on to prevent electric shock. ◆ All peripheral devices must be connected properly under the instructions described in this manual. Failure to comply will result in accidents.
After power-on	 Danger	<ul style="list-style-type: none"> ◆ Do not open the AC servo drive's cover after power-on. Failure to comply may result in electric shock. Do not touch any I/O terminal of the AC servo drive. Failure to comply may result in electric shock.
	 Warning	<ul style="list-style-type: none"> ◆ Do not touch the rotating part of the motor during the motor auto-tuning or running. Failure to comply will result in accidents. ◆ Do not change the default settings of the AC servo drive. Failure to comply will result in damage to the AC servo drive.
During operation	 Danger	<ul style="list-style-type: none"> ◆ Do not touch the fan or the discharging resistor to check the temperature. Failure to comply will result in personal burnt. ◆ Signal detection must be performed only by qualified personnel during operation. Failure to comply will result in personal injury or damage to the AC servo drive.
	 Warning	<ul style="list-style-type: none"> ◆ Avoid objects falling into the AC servo drive when it is running. Failure to comply will result in damage to the AC servo drive. ◆ Do not start/stop the AC servo drive by turning the contactor ON/OFF. Failure to comply will result in damage to the AC servo drive.
During maintenance	 Danger	<ul style="list-style-type: none"> ◆ Repair or maintenance of the AC servo drive may be performed only by qualified personnel. Failure to comply will result in personal injury or damage to the AC servo drive. ◆ Do not repair or maintain the AC servo drive at power-on. Failure to comply will result in electric shock. ◆ Repair or maintain the AC servo drive only ten minutes after the AC servo drive is powered off. This allows for the residual voltage in the capacitor to discharge

Use	Safety Grade	Precautions
		<p>to a safe value. Failure to comply will result in personal injury.</p> <ul style="list-style-type: none"> ◆ Ensure that the AC servo drive is disconnected from all power supplies before starting repair or maintenance on the AC servo drive. ◆ Set and check the parameters again after the AC servo drive is replaced. ◆ All the pluggable components must be plugged or removed only after power-off. ◆ The rotating motor generally feeds back power to the AC servo drive. As a result, the AC servo drive is still charged even if the motor stops, and the power supply is cut off. Thus ensure that the AC servo drive is disconnected from the motor before starting repair or maintenance on the AC servo drive.

1.2 Servo drive scrap matters needing attention

Please note:
<ul style="list-style-type: none"> ◆ The electrolytic capacitors on the main circuits and PCB may explode when they are burnt. ◆ Poisonous gas is generated when the plastic parts are burnt. ◆ Treat them as ordinary industrial waste.

Chapter 2 Product Specifications

2.1 Model Code

2.1.1 Explanation to nameplate



2-1 Nameplate

2.1.2 Series Description

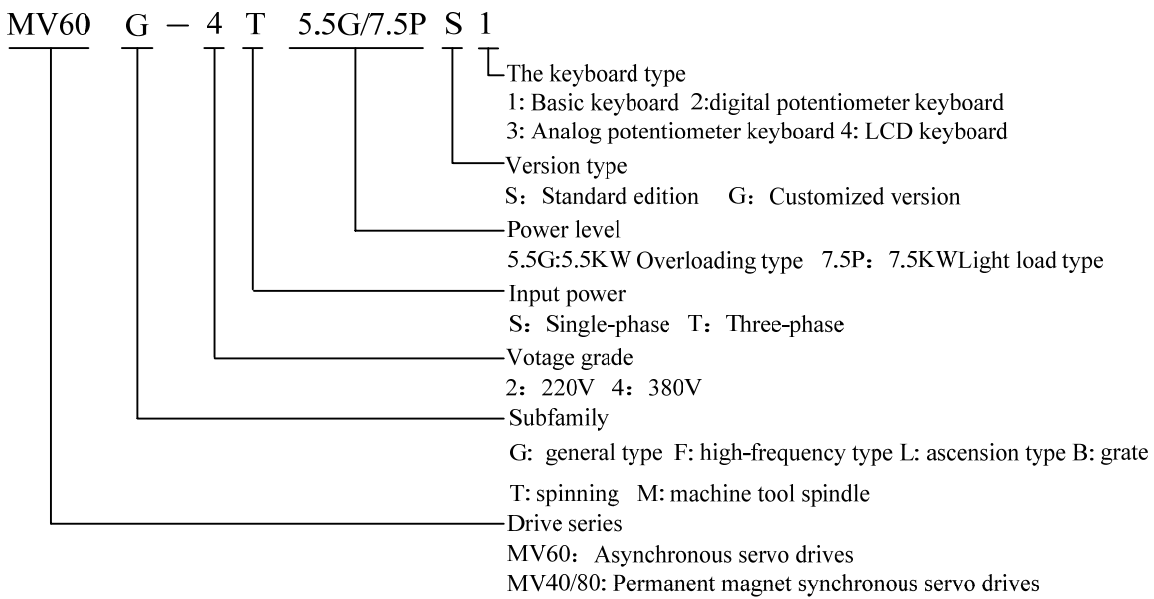

2-2 Servo servo drive series

2.2 Technical Specifications

Chart 2-1 Technology index

Item		Specifications
Input	Rated voltage, frequency	single-phase:220V±15%,50Hz/60Hz,frequency:±5% three-phase:380V±15%,50Hz/60Hz,frequency:±5%
	Rated current	Refer to the rating (Chart 2-2)
Output	Voltage	0~input voltage
	Frequency	0~400Hz
	Current overload capacity	150% Rated current for 1min,180% Rated current for 10s, 200% Rated current for 1s

Item		Specifications
Standard functions	Modulation Mode	The magnetic flux vector PWM modulation
	Motor type	Induction motors
	Speed range	Closed-loop vector (asynchronous)1:5000 Open-loop vector 1:200 V/F1:100
	Startup torque	Closed-loop vector (asynchronous)0Hz 180% Open-loop vector 0.25Hz 150% V/F0.5Hz 150%
	Speed stability accuracy	Closed-loop vector (asynchronous)0.02% Open-loop vector 0.2% V/F0.5%
	Velocity pulsation	Closed-loop vector (asynchronous)0.1% Open-loop vector 0.3%; V/F0.5%
	Frequency accuracy	Digital setting: Max frequency $\times\pm 0.02\%$; Analog setting: Max frequency $\times\pm 1\%$
	Torque boost	Fixed boost Customized boost 0.1%–30.0%
	V/F curve	Straight-line curve, 4 kinds of users set V/F curve,A variety of torque characteristic curve
	Ramp mode	Two kinds of way:Straight-line ramp、S-curve ramp Four groups of acceleration/deceleration time with the range of 0.1~3600s
	DC braking	DC braking frequency:0.00~60.00Hz Braking time: 0.1~30.0s
	Jog	Jog frequency range:0.10~60.00Hz Jog acceleration/deceleration time:0.1~60.0s, Jog time interval can be set
	Multistage speed operation	Through the built-in PLC control or terminal control 16 segment speed operation
	Onboard PID	It realizes process-controlled closed loop control system easily.
	Automatic energy saving operation	Automatic optimization control according to the load situation, achieve energy-saving operation
	Auto voltage regulation(AVR)	It can keep constant output voltage automatically when the mains voltage changes.
	Speed tracking start function	Rotation of motor no impact smooth start
	Automatic current limiting	Current limit automatically during the operation, prevent frequent over-current fault tripping
	Textile pendulum frequency	Textile pendulum frequency control, the realization of center frequency adjustable frequency function
	Fixed-length control	Through the terminal count input function, the realization of fixed length control
Busbar voltage over-voltage suppression	Real-time dynamic control of busbar voltage, prevent the frequent overvoltage fault tripping	
Power dip ride through	The load feedback energy compensates the voltage reduction so that the AC servo drive can continue to run for a short time.	
Run control	Bind function	Bind the run command channel and the frequency of a given channel, synchronous switch

Item		Specifications
	Run the command channel	Operation panel control command channel、terminal control command channel、Modbus/MXLink communication command channel. Can switch through a variety of ways.
	Given frequency channel	Keyboard setting,analog voltage,Analog current setting, simple PLC setting, Multistage speed setting, process of the closed loop setting、Modbus/MXLink communications setting. Can switch through a variety of ways.
	Protection mode	Motor short-circuit detection at power-on, input/output phase loss protection, overcurrent protection, overvoltage protection, undervoltage protection, overheat protection and overload protection.
	Auxiliary frequency source	It can implement fine tuning of auxiliary frequency and frequency synthesis.
Peripheral interface	Analog input	3 roads analog signal input 2 roads 0~10V/4~20mA,1 road differential input -10~+10V
	Analog output	2 roads analog signal output 0~10V/4~20mA, Can realize the set frequency, output frequency and so on the analog output.
	Digital input	8-way multi-function input terminals,X8/DI high-speed pulse input terminals, maximum support (50KHz)
	Digital output	2 ways multifunctional output terminals,Y2/DO high-speed pulse output terminals, maximum support (50KHz)
	2 ways relay output	R relay output MA NC,MB NO,MC COM T relay output M1 NC,M2 NO,M3 COM
	Configurable PLC card	6 ways input terminals, 4 ways output terminals; basic instruction processing speed is 0.084 us/step, comprehensive instruction processing speed for step 1 k/ms, program capacity of 12 K steps
Communication	485 communication	Standard 485 difference signal, support the Modbus protocol and MXLink protocol
Panel	LED display	It can display a set frequency, output frequency, output voltage, output current and other parameters
	Key lock to choose	By setting the buttons can change some or all of the lock, in order to prevent wrong operation
	Multifunctional MK key	Can realize point, free downtime, running direction switch, menu to switch, command channel switch
	Outer join	For 485 interface between panel and control panel, built-in voltage chip, more than 100 m distance connection can be realized
Other	Installation location	Indoor, free from direct sunlight, dust, corrosive gas, combustible gas, oil smoke, vapour, drip or salt.
	Ambient temperature	-10℃~50℃,de-rated if the ambient temperature is more than 40℃
	Altitude	Lower than 1000 m
	Humidity	5%~95%RH, without condensing
	Vibration	Less than 5.9m/s ² (0.6g)
	Storage	-40℃~+70℃

Item	Specifications
temperature	

2.3 Servo drive model and adaptation motor

Chart 2-2 Servo drive adaptation motor list

Number	Model	Rated capacity (KWA)	Rated power current(A)	Rated output current(A)	Motor
1	MV-2S0.4GS	1.0	4.5	3.1	0.4
2	MV-2S0.75GS	1.5	9.3	4.7	0.75
3	MV-2S1.5GS	3.0	16.5	7.8	1.5
4	MV-2S2.2GS	4.0	23	10	2.2
5	MV-4T0.75GS	1.5	3.4	2.5	0.75
6	MV-4T1.5GS	2.5	5.0	3.7	1.5
7	MV-T2.2GS	3.0	5.8	5.0	2.2
8	MV-4T4GS	5.9	10.5	9.3	3.7
9	MV-4T5.5GS	8.6	16.5	14.0	5.5
10	MV-4T7.5GS	11.2	20.5	17.0	7.5
11	MV-4T11GS	17.0	26.0	25.0	11
12	MV-4T15GS	21.0	35.0	32.0	15
13	MV-4T18.5GS	24.0	47.0	38.0	18.5
14	MV-4T22GS	25.0	56.0	45.0	22
15	MV-4T30GS	35.0	70.0	60.0	30
16	MV-4T37GS	40.0	80.0	75.0	37
17	MV-4T45GS	50.0	94.0	92.0	45
18	MV-4T55GS	60.0	128.0	115.0	55
19	MV-4T75GS	80.0	160.0	150.0	75
20	MV-4T90GS	95.0	190.0	180.0	90
21	MV-4T110GS	120.0	225.0	215.0	110
22	MV-4T132GS	140.0	265.0	260.0	132
23	MV-4T160GS	178.0	310.0	305.0	160
24	MV-4T185GS	198.0	345.0	340.0	185
25	MV-4T200GS	210.0	385.0	380.0	200
26	MV-4T220GS	230.0	430.0	425.0	220
27	MV-4T250GS	265.0	485.0	480.0	250
28	MV-4T280GS	290.0	540.0	530.0	280
29	MV-4T315GS	330.0	610.0	600.0	315
30	MV-4T350GS	360.0	630.0	650.0	350
31	MV-4T400GS	450.0	715.0	720.0	400

2.4 Servo drive parts name

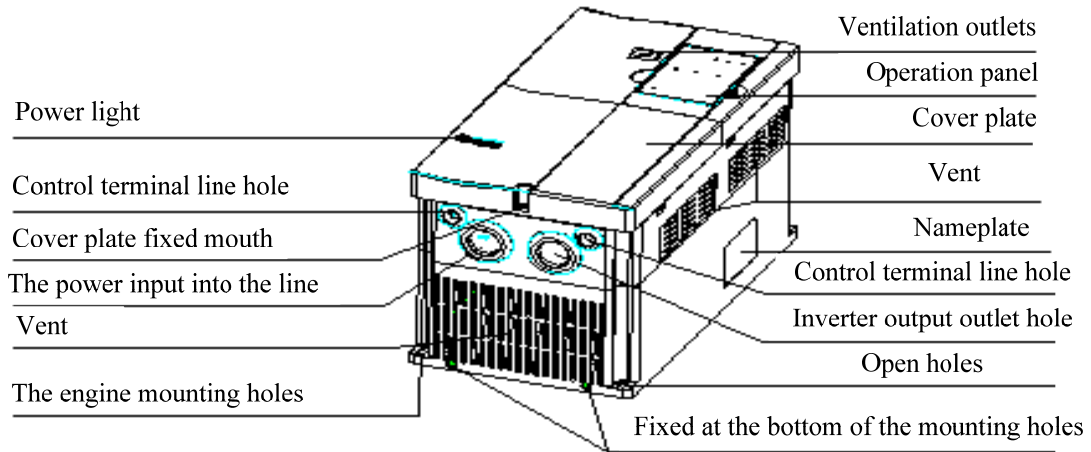

2-3 Servo drive parts name

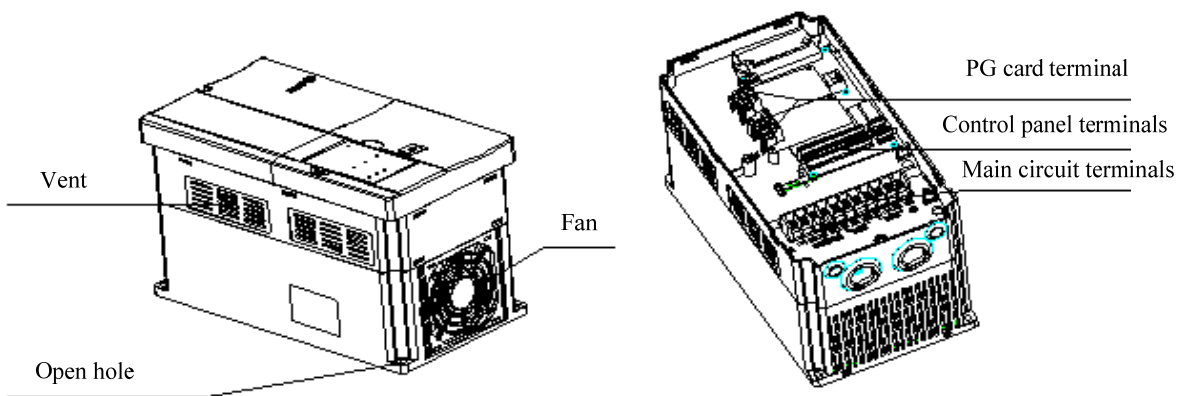

2-4 Servo drive parts name

Chapter 3 Wiring Installation

3.1 Servo drive overall dimensions

Application: MV-2S0.4GS~2.2GS, MV-4T0.4GS~2.2GS

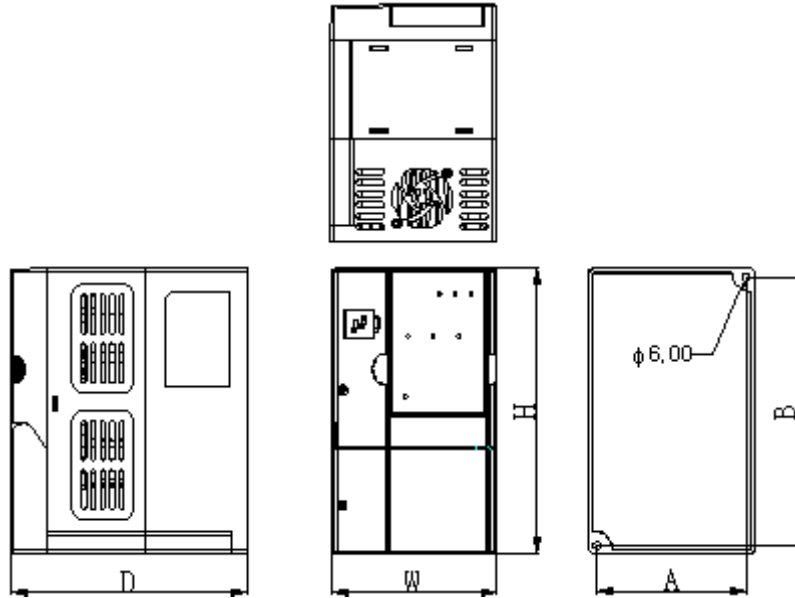

3-1 Boundary dimension (B1 Plastic shell series)

Application: MV-4T4GS~11GS

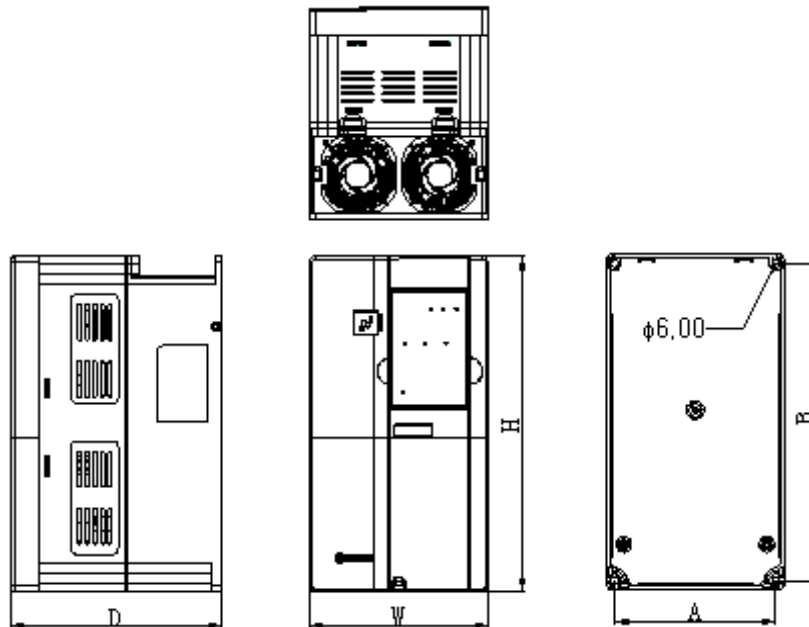

3-2 Boundary dimension (B2、B3 Plastic shell series)

Application: MV-4T15GS~315GS

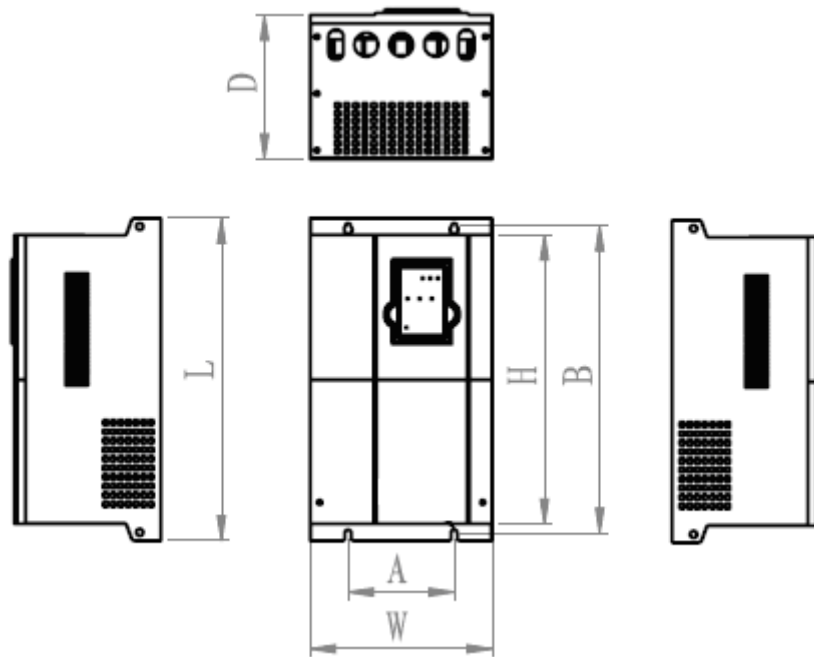

3-3 Boundary dimension (C Metal wall series, D is for the metal wall can also be used for vertical series)

Chart 3-1 Dimension

Power	A(mm)	B(mm)	H(mm)	W(mm)	D(mm)	L(mm)	Diameter of mounting recess(mm)	Structural type of code
	Installation dimension		Boundary dimension					
MV-2S0.4GS	94.00	169.00	180.00	105.00	150.00	180.00	6.00	B1
MV-2S0.75GS								
MV-2S1.5GS								
MV-2S2.2GS								
MV-4T0.75GS								
MV-4T1.5GS								
MV-4T2.2GS	126.00	246.00	260.00	140.00	165.00	260.00	6.00	B2
MV-4T4GS								
MV-4T5.5GS								
MV-4T7.5GS	154.00	305.00	320.00	170.00	193.60	320.00	6.00	B3
MV-4T11GS								
MV-4T15GS	140.00	406.00	382.00	240.00	190.00	426.00	6.50	C1
MV-4T18.5GS								
MV-4T22GS								
MV-4T30GS	150.00	478.00	452.00	290.00	212.00	494.00	6.50	C2
MV-4T37GS								
MV-4T45GS	190.00	574.00	540.00	315.00	243.00	600.00	8.50	C3
MV-4T55GS								
MV-4T75GS	300.00	733.00	703.00	390.00	302.00	760.00	9.00	D1
MV-T90GS								

Power	A(mm)	B(mm)	H(mm)	W(mm)	D(mm)	L(mm)	Diameter of mounting recess(mm)	Structural type of code
	Installation dimension		Boundary dimension					
MV-4T110GS	380.00	733.00	703.00	390.00	302.00	760.00	11.00	D2
MV-4T132GS								
MV-4T160GS								
MV-4T185GS								
MV-4T200GS	500.00	1025.00	990.00	640.00	370.00	1070.00	13.00	D3
MV-4T220GS								
MV-4T250GS								
MV-4T280GS								
MV-4T315GS								

注:A and B are plastic shell series, C is metal wall series, D is for the metal wall can also be used for vertical series.

3.2 Operation panel size

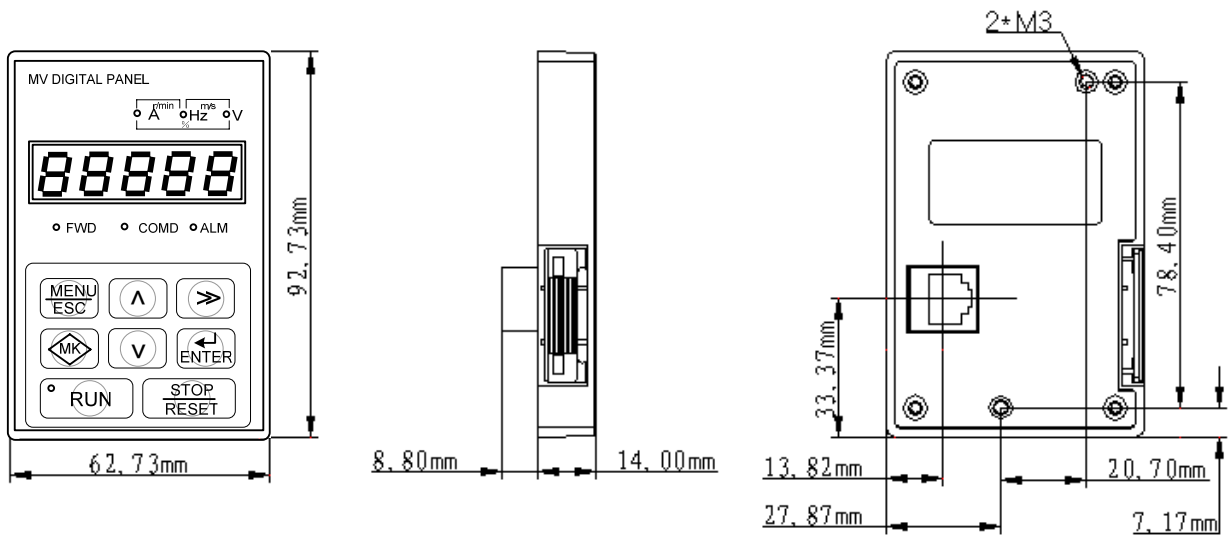
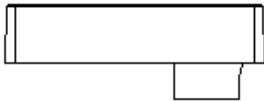

3-4 Operation panel size diagram

3.3 The installation of the servo drive

3.3.1 Installation of interval and distance

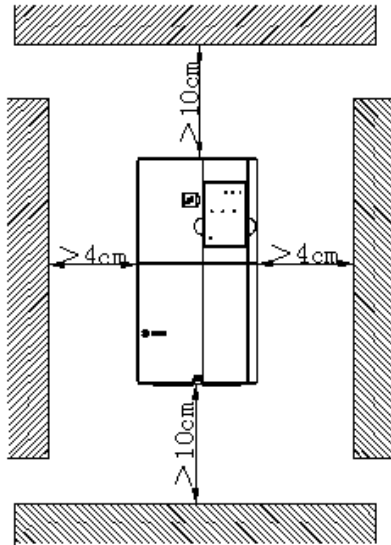

3-5 Below the 11KW

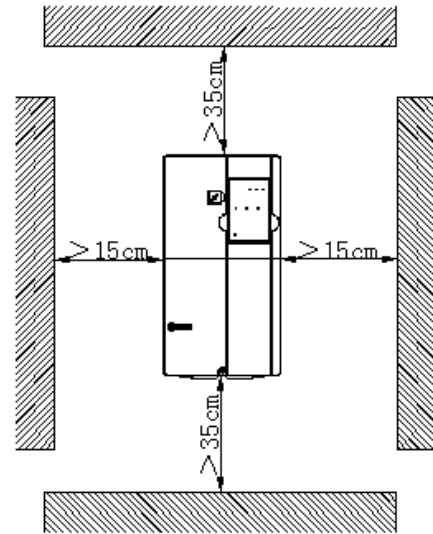

3-6 More than 15 kw

3.3.2 Disassembly and installation of the servo drive

Panel disassembly and installation:

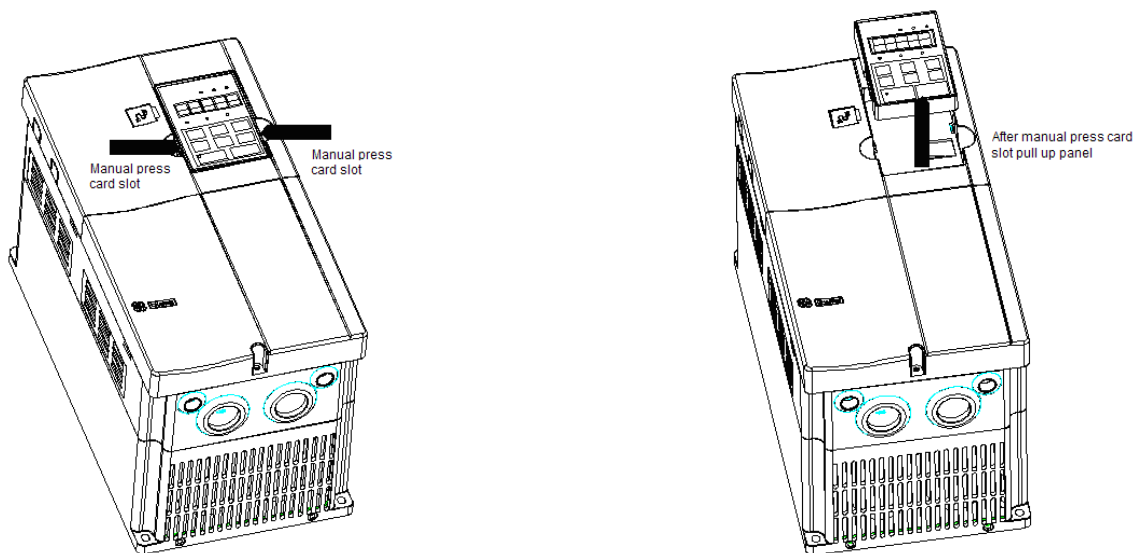

3-7 Panel disassembly and installation diagram

3.3.3 Remove the front cover of the servo drive

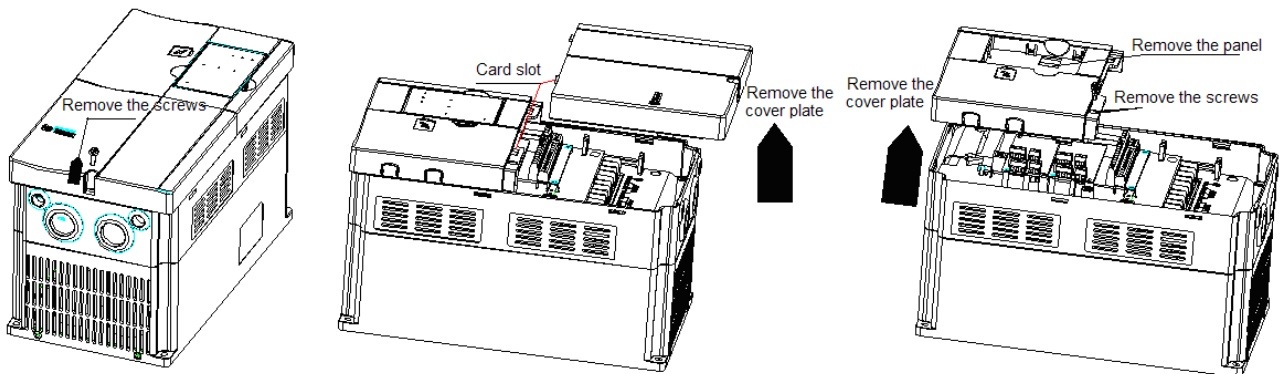

3-8 The diagram of the removal front cover

Remove the steps:

- Step 1: Remove fixed screw of the down cover board
- Step 2: Remove the down cover plate
- Step 3: remove the operation panel
- Step 4: Remove fixed screw of the up cover board
- Step 2: Remove the up cover plate

3.4 Description of Main Circuit wiring and Terminals

3.4.1 Single/three phase less than or equal to 2.2KW servo drive terminals

MV-2S0.4GS~2.2GS MV-4T0.75 GS~2.2GS

Main circuit terminals:

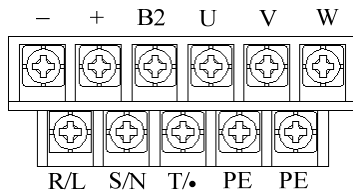

3-9 Main circuit terminals

Description of main circuit terminals:

Chart 3-2 Description of main circuit terminals

Terminal	Function declaration
R、S、T	Three-phase power input
L、N	Single-phase power input (T terminal without)
U、V、W	Output three-phase AC
+、-	Busbar voltage terminal
B2、+	Reserved external braking resistor terminals
PE	Earth terminal

3.4.2 Three phase more than or equal to 4KW servo drive terminals

MV-4T4GS~18.5GS

Main circuit terminals:

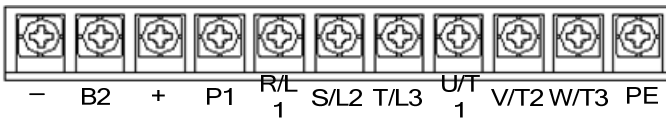

3-10 Main circuit terminals

Description of main circuit terminals:

Chart 3-3 Description of main circuit terminals

Terminal	Function declaration
R/L1、S/L2、T/L3	Three-phase power input
U/T1、V/T2、W/T3	Output three-phase AC
+、-	Busbar voltage terminal
B2、+	Reserved external braking resistor terminals
P1、+	Connect the DC reactor

Terminal	Function declaration
PE	Earth terminal

MV-4T22GS~110GS

Main circuit terminals:



R/L1 S/L2 T/L3 P1 + B2 - U/T1 V/T2 W/T3

3-11 22~30KW Main circuit terminals

Chart 3-4 Control circuit terminal

Terminal	Function declaration
R/L1、S/L2、T/L3	Three-phase power input
U/T1、V/T2、W/T3	Output three-phase AC
+、-	Busbar voltage terminal
B2、+	Reserved external braking resistor terminals
P1、+	Connect the DC reactor

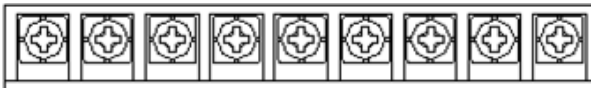

R/L1 S/L2 T/L3 P1 + - U/T1 V/T2 W/T3

3-12 22~110KW Main circuit terminals

Description of main circuit terminals:

Chart 3-5 Control circuit terminal

Terminal	Function declaration
R/L1、S/L2、T/L3	Three-phase power input
U/T1、V/T2、W/T3	Output three-phase AC
+、-	Busbar voltage terminal
P1、+	Connect the DC reactor

3.4.3 The servo drive system main circuit terminal wiring and grounding

- Circuit breaker MCCB or leakage switch
With short circuit protection, overload protection function.
- Electromagnetic contactor
Contactor only to control the power supply, can't be used to directly control the start and stop of frequency converter.
- AC input reactor
When the AC input side converter and power between higher harmonic is bigger, can not meet the requirement of the system, can add AC input reactor.
- Input EMI noise filter
Optional EMI filter to suppress the high frequency noise interference from servo drive power supply cord.
- Output EMI noise filter
Optional EMI filter to suppress the output side of the servo drive noise interferences and wire leakage current.
- Output AC reactor
When the servo drive to motor connection more than 60 meters, suggest to install AC output reactor. To avoid electrical insulation damage, leakage flow and servo drive frequency protection.
- Safety ground

Servo drive within the leakage current, in order to ensure the safety, the servo drive and motor must be grounded, grounding resistance should be less than 10 Ω.

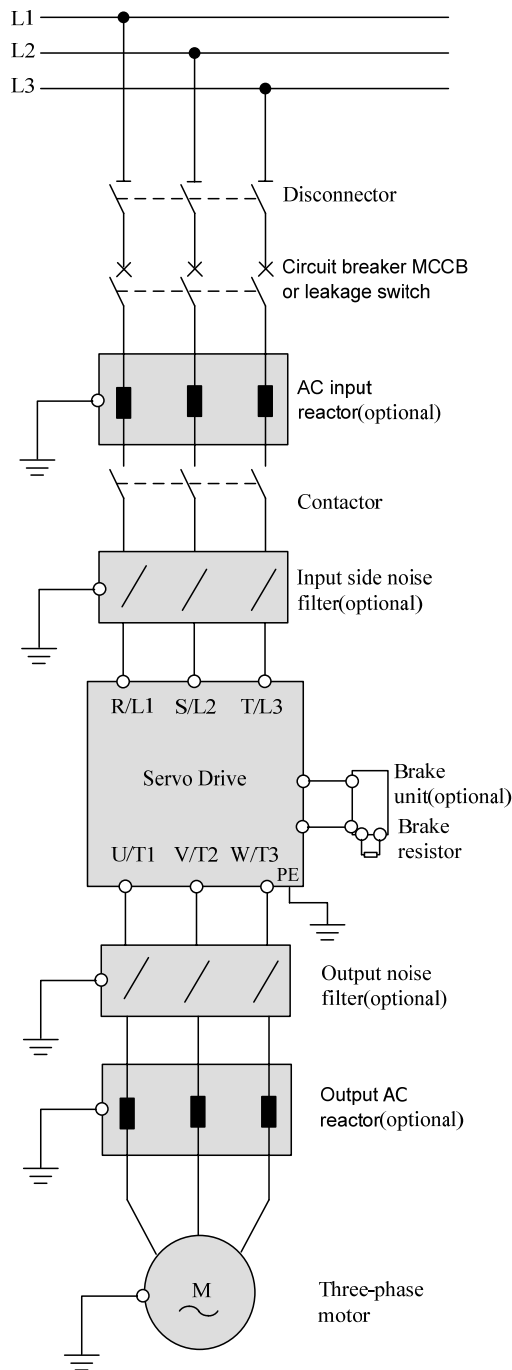

3-13 The servo drive and the peripheral equipment standard connection diagram

Notice

- ◆ Do not install capacitance or surge suppressor in the servo drive output side, otherwise easy to damage.
- ◆ Communication lines need to use twisted-pair shielded wire.

Grounding:

Terminal  PE, this terminal must be reliably connected to the main earthing conductor.

Ground wire do not share with welding machine and power equipment, etc.

Ground wire, please use the specifications stipulated in the technical standards of electrical equipment, and with the pick up location as short as possible.

Using two or more inverters at the same time, do not use ground wire forming circuit.

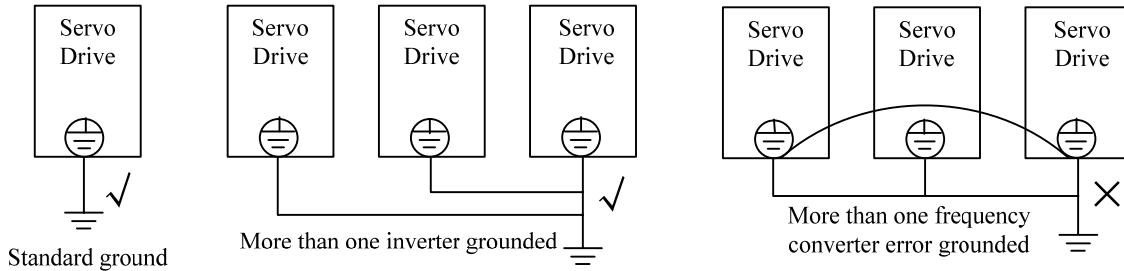

3-14 Servo drive grounding diagram

3.4.4 The servo drive and motor wiring diagram and the matters needing attention

- Is absolutely forbidden to will power output terminals.
- Do not directly touch output terminals, or to match the output and servo drive shell sub, otherwise there will be a risk of electric shock and short circuit.
- Absolute ban the use of phase shift capacitor.
Absolute ban the use of electromagnetic switch.
- In order to switch the power frequency power supply and set the electromagnetic contactor, must ensure that the servo drive and motor stop to switch
- Motor used in for the first time or place for a long time before using should be tested for motor insulation inspection, prevent damage to the servo drive for motor winding insulation failure. When testing, please use 500v voltage megohmmeter, should guarantee the measured insulation resistance is not less than 5 mΩ.

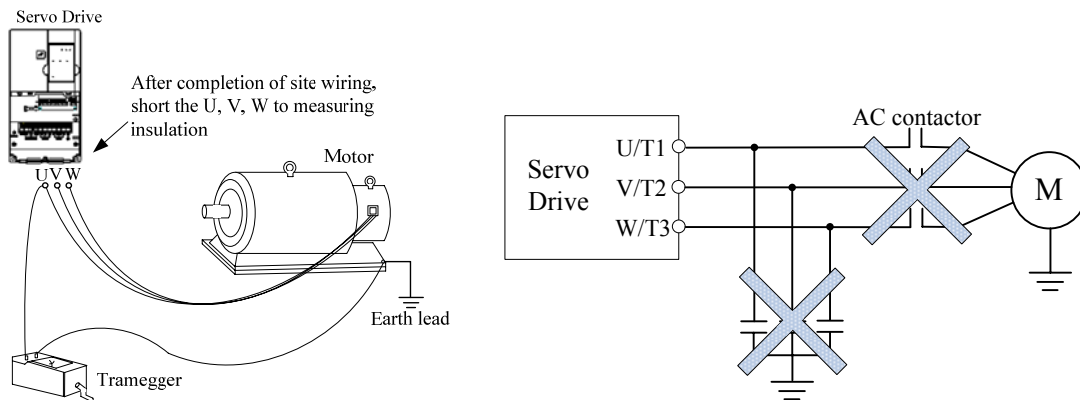

3-15 The servo drive output is prohibited to use capacitor diagram

3.5 The servo drive control circuit wiring and terminals

3.5.1 Single/three phase less than or equal to 2.2 KW servo drive terminals

Control circuit terminal:

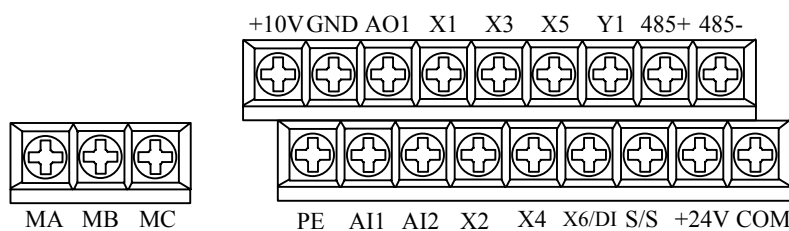

3-16 Control circuit terminal diagram

Description of control circuit terminals:

Chart 3-6 Description of control circuit terminals

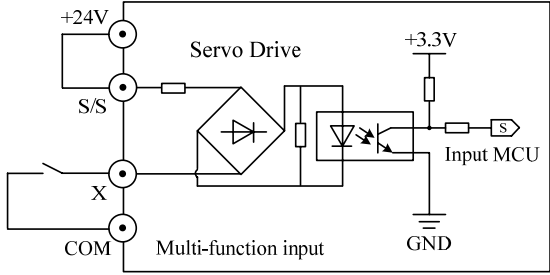
Type	Terminal Symbol	Function description	Specification
Communication terminal	RS485+	485 Positive differential signal	Standard RS - 485 communication interface Please use the twisted-pair shielded wire
	RS485-	485 Negative differential signal	
Analog input	AI1、 AI2	Analog input voltage/current GND	AI1 input:0~10V or 0~20mA AI2 input:0~10V Input resistance: It is 20KΩ at the time of voltage input and 500Ω at the time of current input ; error ±1%,30℃
Analog output	AO1	Analog voltage output GND	Output 0~10V Error±1%, 30℃
on-off input	S/S	Multi-function input terminal X1 ~ X6 public side	Input resistance:4.3KΩ; Voltage range: 20~30V Maximum input frequency:1KHz 
	X1~X6	Multi-function input terminal	
	X6/DI	X6 can be used as ordinary multi-function terminal(as X1~X5),also programmable as high-speed pulse input port	
+24V power	+24V	Provide reference 24v power	The maximum output current 200mA
24V GND	COM	24V GND	
+10V power	+10V	Provide reference 10v power	The maximum output current 40mA
10V GND	GND	Analog signal and 10v GND	Segregate inside and COM
on-off output	Y1	Multi-function terminal output	NPN switch output,0~50 mA
Relay output	MA、 MB、 MC	Multi-function relay output	220~250V AC 7A ; 24~30 DC 7A original state :MA-MC NO; MB-MC NC
GND	PE	Shield earthing	Internally connected to the terminals of main loop PE

Servo Servo drive basic wiring:

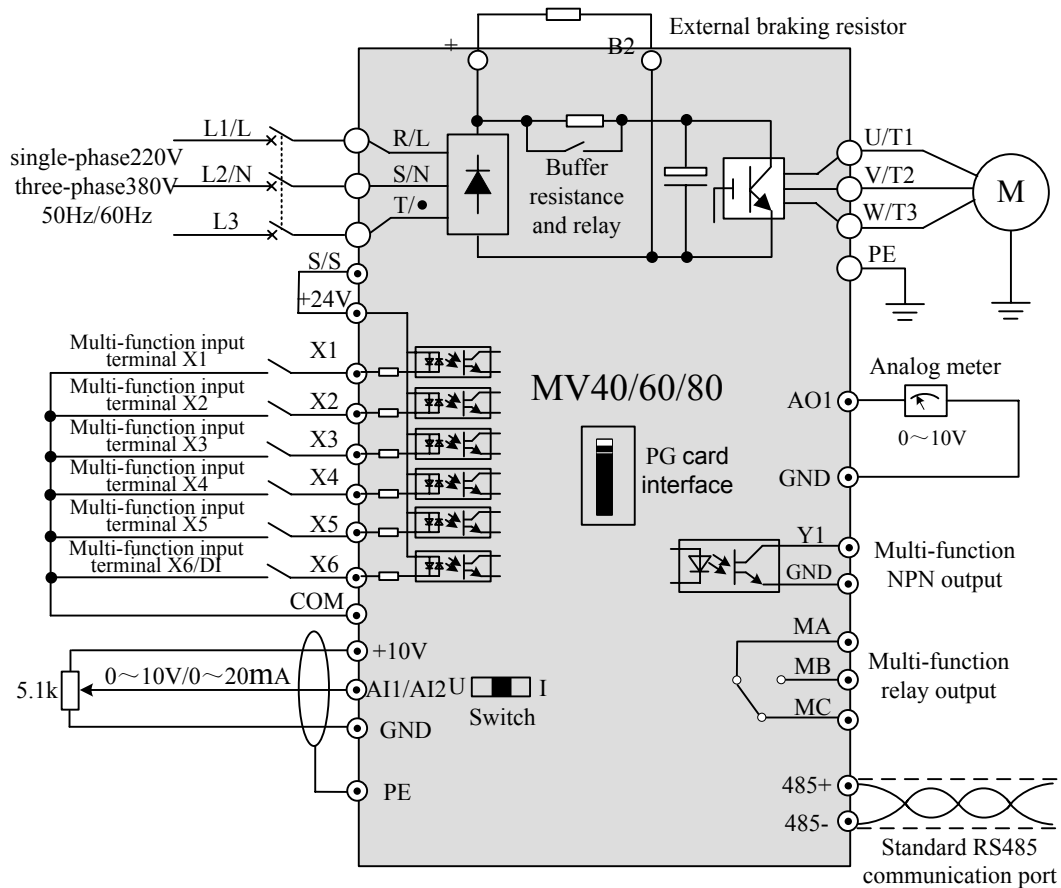

3-17 Single/three phase servo drive basic wiring diagram

3.5.2 Single/three phase more than or equal to 2.2 KW servo drive terminals

Control circuit terminal:

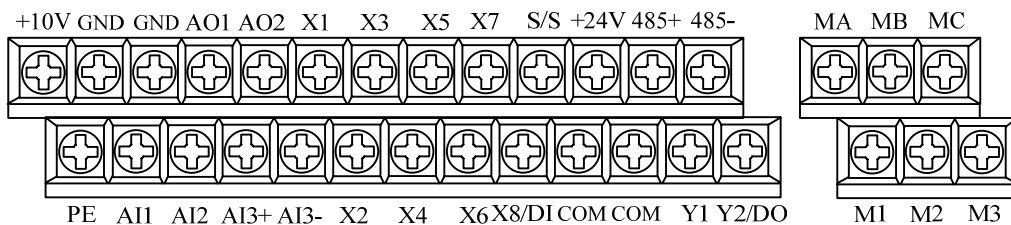

3-18 Control circuit terminal diagram

Description of control circuit terminals:

Chart 3-7 Description of control circuit terminals

Type	Terminal Symbol	Function description	Specification
Communication terminal	RS485+	485 Positive differential signal	Standard RS - 485 communication interface Please use the twisted-pair shielded wire
	RS485-	485 Negative differential signal	
Analog input Analog input	AI1、 AI2	Analog input voltage/current GND	AI1 input:0~10V or 0~20mA AI2 input:0~10V Input resistance: It is 20KΩ at the time of voltage input and 500Ω at the time of current input ; error ±1%

Type	Terminal Symbol	Function description	Specification
	AI3+	The analog input voltage difference, AI3 + for the same phase input, AI3 - for inverting input;	The input voltage range: -10~10V Input impedance: 100kΩ when the input voltage Error±1%
	AI3-	The single-ended input analog voltage, AI3 + for signal input, AI3 - connect to GND GND	
Analog output	AO1、AO2	Analog voltage output GND	Output 0~10V or 0~20mA Selected through the dial code switch 3, 4 Error ±1%
On-off input	S/S	Multi-function input terminal X1 ~ X8 public side	Input impedance: 4.3KΩ; Voltage range: 20~30V Maximum input frequency: 1KHz
	X1~X8	Multi-function input terminal	
	X8/DI	X8 can be used as ordinary multi-function terminal(as X1 ~ X7),also programmable as high-speed pulse input port	
+24V power	+24V	Provide reference 24v power	The maximum output current 200mA
24VGND	COM	24V GND	
+10V power	+10V	Provide reference power 10v	The maximum output current 40mA
10VGND	GND	Analog signal and 10v GND	Segregate inside and COM
On-off output	Y1	Multi-function terminal output	NPN switch output 0~50mA
High-speed pulse output	Y2/DO	The pulse signal output terminal	Output frequency: 0~50KHz, 0~50mA
Relay output	MA、MB、MC	Multi-function relay terminal output	220~250V AC 7A;24~30V DC 7A Original state :MA-MC NO;MB-MC NC
	M1、M2、M3	Multi-function relay terminal output	220~250V AC 7A;24~30V DC 7A Original state :M1-M3 NO;M2-M3 NC
GND	PE	GND	Internally connected to the terminals of main loop PE

Servo Servo drive basic wiring:

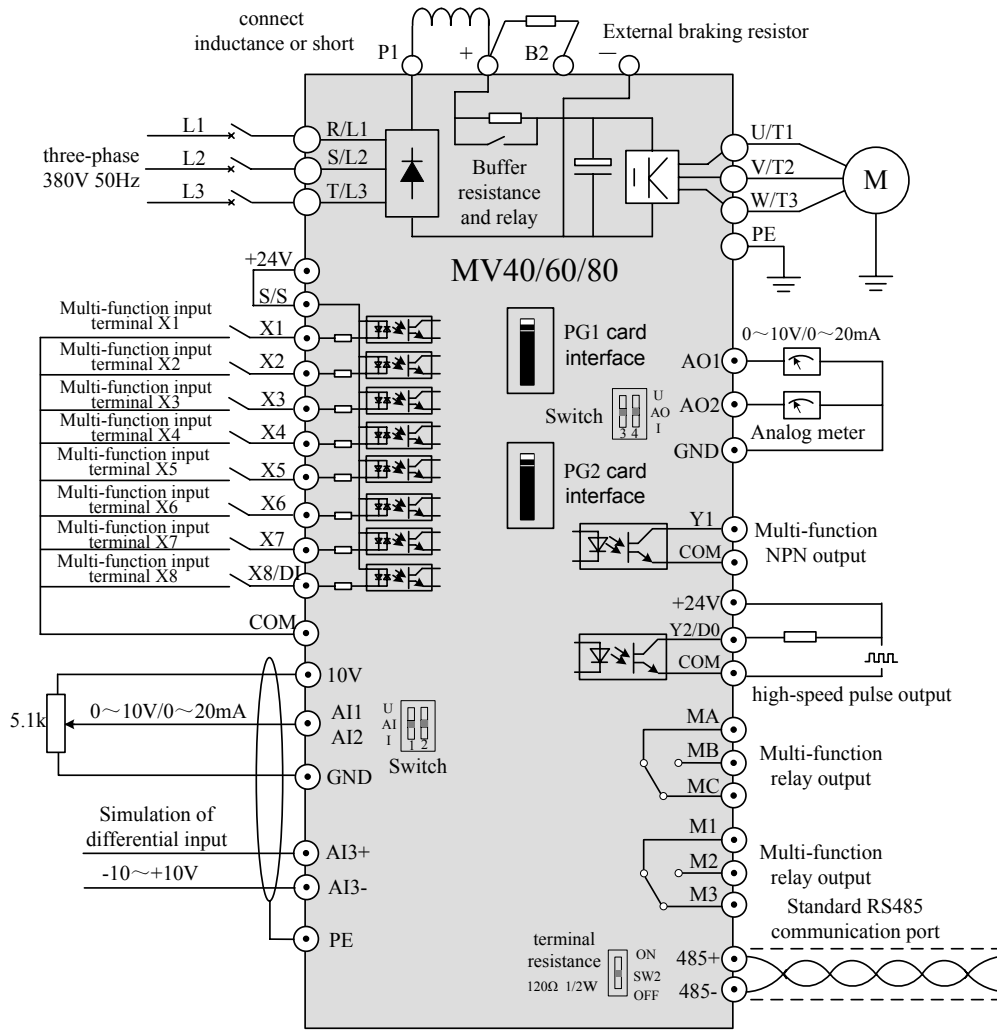

3-19 Three phase servo drive basic wiring diagram

3.5.3 Communication wiring

Servo Servo drive with RS485 interface communication:

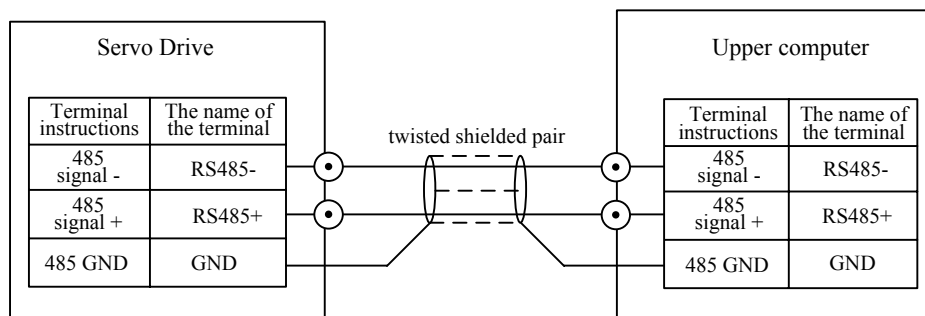

3-20 RS485 and RS485 communication wiring

Servo drive with RS232 communication interface:

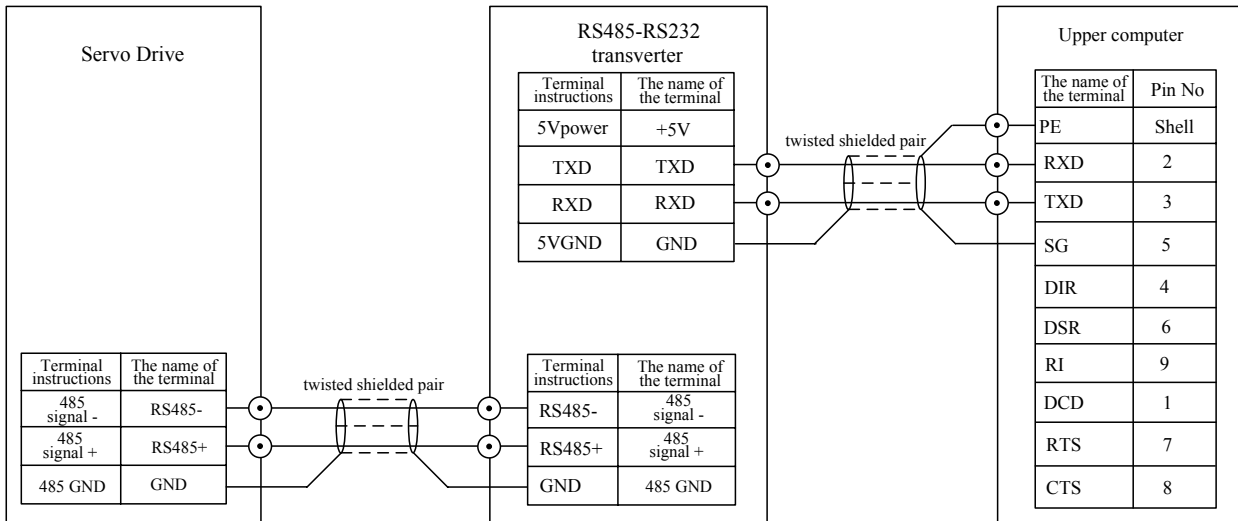

3-21 485 and RS232 communication wiring

More than one servo drive articulated in the same RS485 system wiring:

More than one servo drive to hook up in the same RS485 system, communication interference enhancement, wiring is very important, recommend the user according to the following way connection:

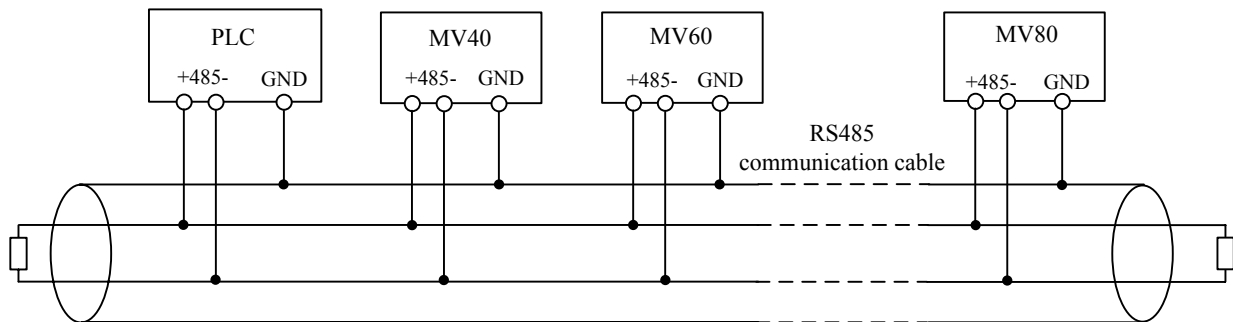

3-22 Wiring diagram

Note

- ◆ It is recommended to use standard 485 communications.
- ◆ Please use the standard twisted-pair shielded wire, cable shielding layer of proximal (on one end of the frequency converter) should be connected to the servo drive the earthing terminal of PE.
- ◆ Walk line twisted-pair shielded wire should be fully away from the main circuit and high voltage lines.
- ◆ If you use the RS485 / RS232 converter module, can consider to separate power conversion module.
- ◆ If the condition allows, Servo drive carrier frequency can be appropriately reduced.

3.5.4 Analog input wiring

Analog input connection mode:

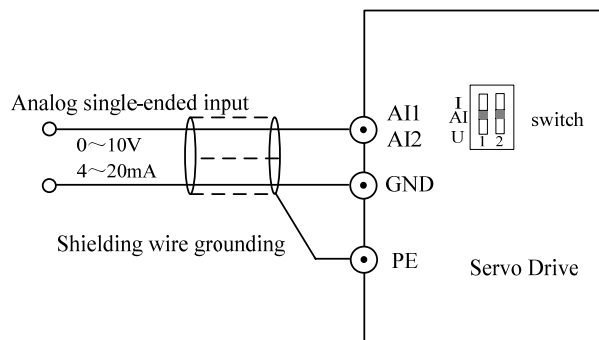

3-23 Single-ended input analog AI

Analog terminal AI1 and AI2 single-ended input:through the dial switch select the input voltage/current selection (0~10V/0~20mA). Below 2.2 KW AI2 only supports the input voltage.

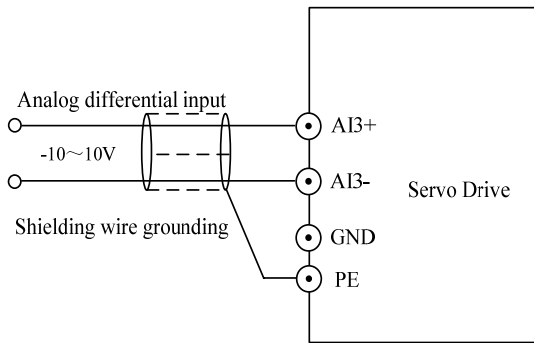

3-24 Analog differential input

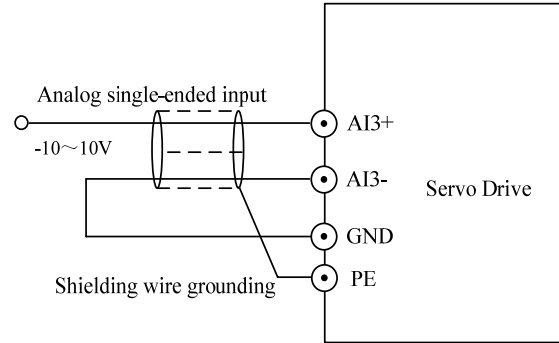

3-25 Analog single-ended input

Analog terminal AI3 differential input/single-ended input: -10~+10V.

Note

- ◆ When using analog input, can Install filter or common-mode inductor between AI and GND.
- ◆ Analog signal easily disturbed, so the shield grounding.

3.5.5 Analog output wiring

Analog output connection mode:

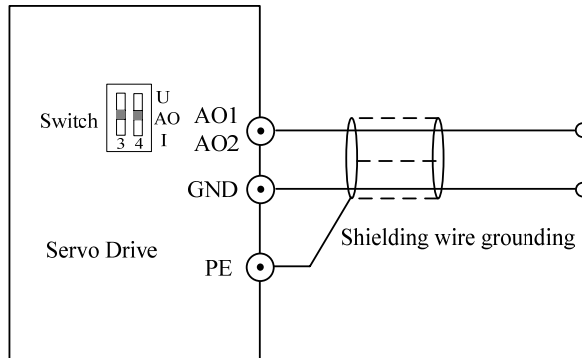

3-26 Analog output

Analog AO1 output: output voltage/current through dial the code switch selection(0~10V/0~20Ma),below 2.2 KW AO1 only supports the output voltage.

3.5.6 Switch input and wiring

1. Dry contact output wiring

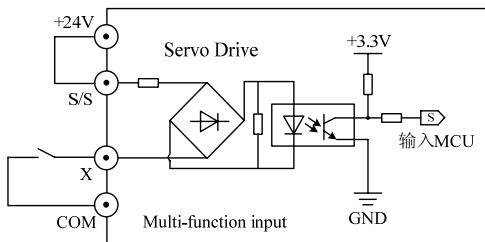

3-27 Using internal power wiring diagram

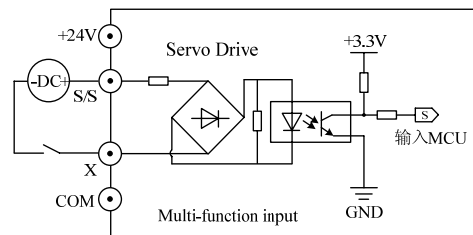

3-28 Using external power wiring diagram

2. External controls source electrode (drain electrode) output wiring

External controller for the NPN emitter output connection.

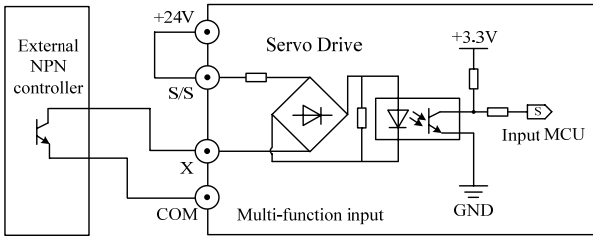

3-29 Using internal power wiring diagram

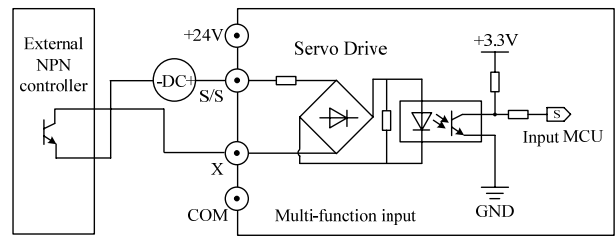

3-30 Using external power wiring diagram

External controller for the NPN emitter output connection.

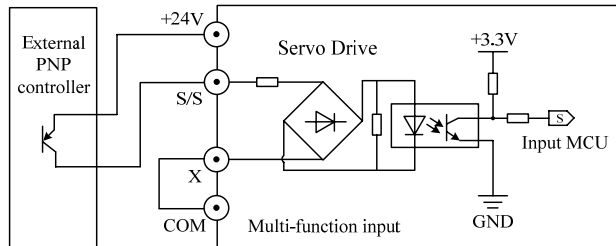

3-31 Using internal power wiring diagram

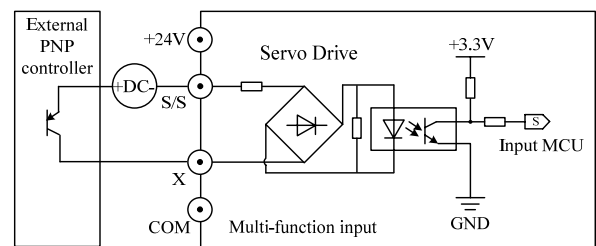

3-32 Using external power wiring diagram

Note

- ◆ Do not short circuit the 24v terminal and COM terminal, otherwise it may cause the damage of the control panel.
- ◆ Multi-function input terminal of the voltage is 20 ~ 30v DC.
- ◆ Please use multicore shielded cable or twisted wire (above 0.5mm²) connection control terminals.
- ◆ Please use the standard twisted-pair shielded wire, cable shielding layer of proximal (on one end of the frequency converter) should be connected to the servo drive the earthing terminal of PE.
- ◆ Walk line twisted-pair shielded wire should be fully away from the main circuit and high voltage lines.

3.5.7 Switch output wiring

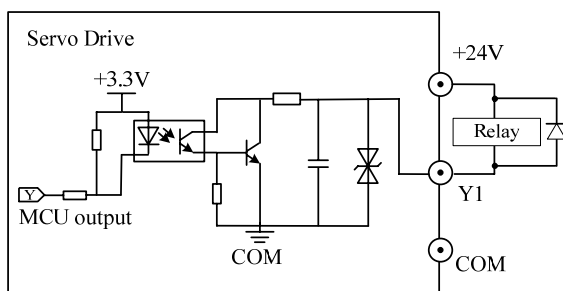

3-33 Switch value Y1 use internal power supply wiring

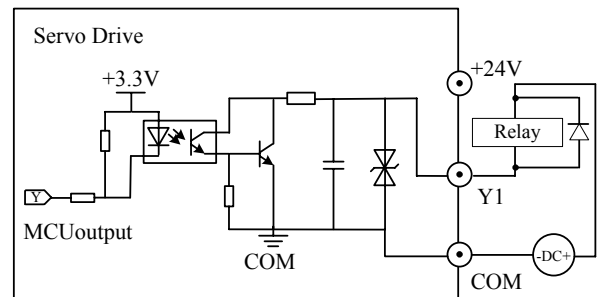

3-34 Switch value Y1 use external power supply wiring

Note

- ◆ Servo drive internal 24v power supply provides 200mA current biggest, If the relay power devices are too small to concatenate the energy consumption resistance to prevent the current is too big to damage the internal power supply.

3.5.8 High-speed pulse output port Y2 / DO, input port X8 / DI

High-speed pulse output port Y2 / DO:

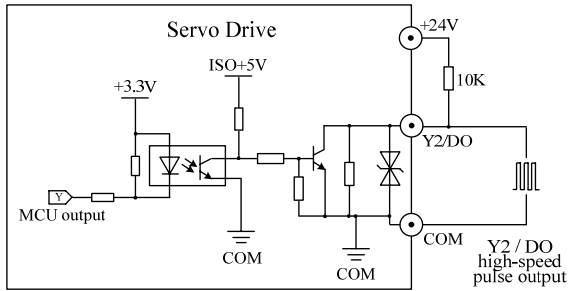

3-35 High-speed pulse using internal output power wiring
High-speed pulse input port Y2 / DO:

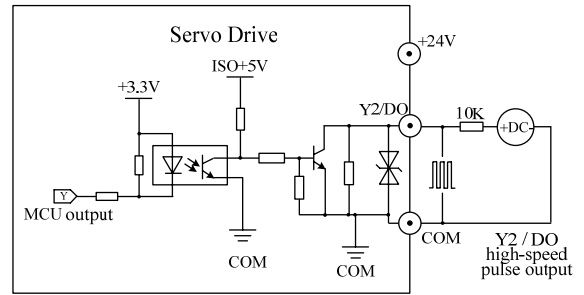

3-36 High-speed pulse using internal input power wiring

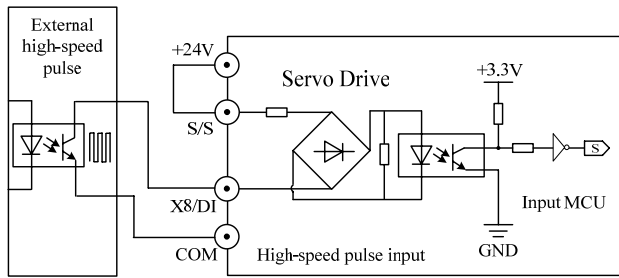

3-37 High-speed pulse using external output power wiring

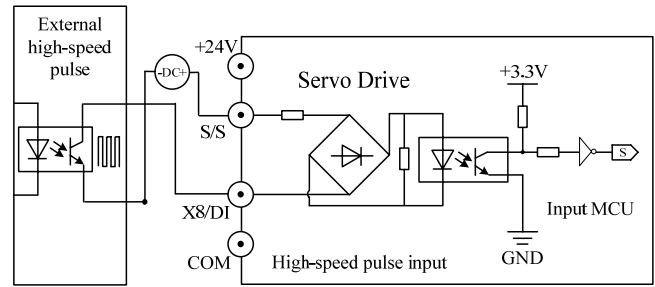

3-38 High-speed pulse using external input power wiring

3.5.9 Relay output wiring

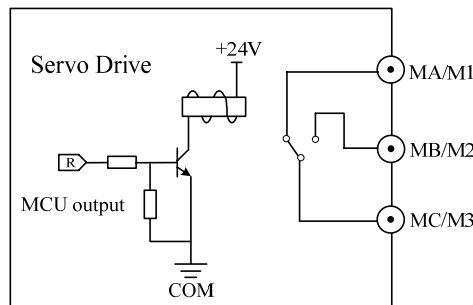

3-39 Relay output wiring

Note

- ◆ Relay 220~250V AC 7A ;24~30V DC 7A.
- ◆ Using the perceptual element such as relay, should be equipped with surge voltage absorbing circuit, varistor, or fly-wheel diode to absorb the circuit produced by the ON-OFF.

3.6 The MV series servo drive system configuration scheme

Chart 3-8 The MV series servo drive system configuration scheme

Servo drive type	Brake unit	Braking resistor unit		Braking torque
		Brake resistor	Number	
MV-2S0.4GS	Standard built-in	200Ω/70W	1	220
MV-2S0.75GS		200Ω/70W	1	125
MV-2S1.5GS		100Ω/260W	1	125
MV-2S2.2GS		70Ω/260W	1	120
MV-4T0.75GS		750Ω/70W	1	130
MV-4T1.5GS		400Ω/260W	1	125
MV-4T2.2GS		250Ω/260W	1	135

Servo drive type	Brake unit	Braking resistor unit		Braking torque
		Brake resistor	Number	
MV-4T4GS		150Ω/390W	1	135
MV-4T5.5GS		100Ω/520W	1	135
MV-4T7.5GS		75Ω/780W	1	130
MV-4T11GS		50Ω/1040W	1	135
MV-4T15GS		40Ω/1560W	1	125
MV-4T18.5GS		32Ω/4800W	1	125
MV-4T22GS	Optional/built-in	27.2Ω/4800W	1	125
MV-4T30GS		20Ω/6000W	1	125
MV-4T37GS	Optional the outer	16Ω/9600W	1	125
MV-4T45GS		13.6Ω/9600W	1	125
MV-4T55GS		10Ω/6000W	1	135
MV-4T75GS		6.8Ω/1200W	1	135
MV-4T90GS		6.8Ω/1200W	1	125
MV-4T110GS		6.8Ω/1200W	1	125

 **Attention**

- ◆ Please in accordance with the data provided by the company to choose the braking resistor value and power.
- ◆ When using external braking unit, properly set brake unit brake voltage grade, such as voltage level setting is not correct, will affect the normal operation of the servo drive.

The brake component options guide:

Table 3-8 provides data for reference. You can select different resistance and power based on actual needs. However, the resistance must not be lower than the recommended value. The power may be higher than the recommended value.

Physical Dimensions of External DC Reactor:

The motor and load's regenerative energy is almost completely consumed on the braking resistor when braking.

According to the formula $U \times U/R = P_b$:

- U refers to the braking voltage at system stable braking.
Different systems select different braking voltages. The 380 VAC system usually selects 700 V braking voltage.
- P_b refers to the braking power.

Selection of Power of Braking Resistor:

In theory, the power of the braking resistor is consistent with the braking power. But in consideration that the de-rating is 70%, you can calculate the power of the braking resistor according to the formula $0.7 \times P_r = P_b \times D$.

- P_r refers to the power of resistor.
- D refers to the braking frequency (percentage of the regenerative process to the whole working process)
General application---10%
Elevator-----20%~30%
Winding and unwinding--20%~30%
Centrifuge-----50%~60%

Chapter 4 The operation of the keyboard

4.1 Operation panel is introduced

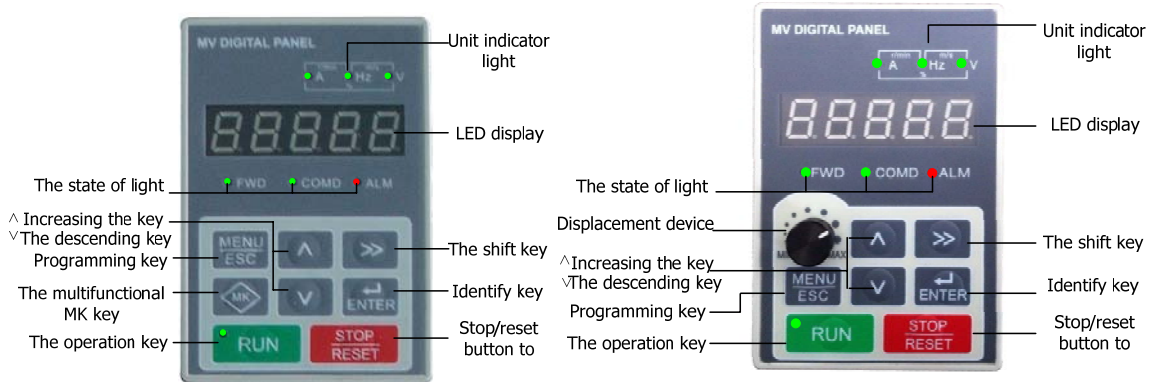

Figure 4-1 operation panel

4.2 Indicator light show

Unit indicator light:

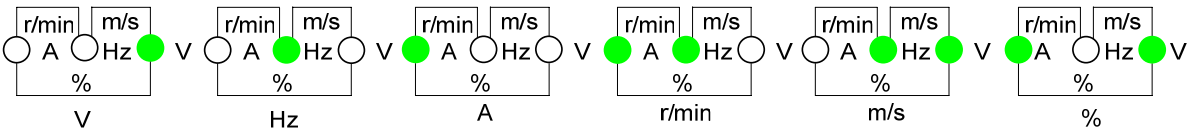

Figure 4-2 units indicator light

Status indicators:

		Meaning	Light color
FWD	Forward/reverse light	Bright: reverse run	green
		Turn out: is running	/
COMD	Run the command channel signals	Bright: operation panel control state	green
		Out: the terminal control state	/
		Flash: serial communication control state	green
ALM	Fault indicator light	Bright: servo drive in fault condition	red
		Flash: frequency converter in the alarm condition	red
RUN	Running status indicator	Bright: Running state	green
		Flash: stop condition	/



4.3 The LED display area

According	Meaning	According	Meaning	According	Meaning	According	Meaning
	0		A		I		S
	1		b		J		T
	2		C		L		t









According	Meaning	According	Meaning	According	Meaning	According	Meaning
	3		c		N		U
	4		d		n		V
	5		E		O		y
	6		F		o		-
	7		G		P		8.
	8		H		q		.
	9		h		r		

4.4 Introduction to run or stop display parameters





Display symbols	Parameter is introduced
	If the character does not flicker, show that displays the current output frequency of the motor; If flashing character, it shows that show the current setting frequency
	According to the output side of U/T1、V/T2、W/T3 output current
	According to the output voltage
	According to frequency converter bus voltage
	Displays the percentage of the output power
	Display output power factor percentage
	According to the AI output voltage, Display panel potentiometer voltage
	Displays the percentage of your AI curve adjustment, The percentage of the display panel potentiometer by the curve
	Switch terminal and status display
	Display terminal count
	Display PLC running stage, stage of multistage position
	Shows the closed loop feedback, closed loop setting (flash), the percentage of the output, the closed-loop error (you need to use the shift key can display hidden)
	Displays the servo drive overload or motor overload the percentage of the total (you need to use the shift key can display hidden)

Display symbols	Parameter is introduced
	According to the temperature of the servo drive
	Show the current motor running speed(You need to use the shift key can display hidden place)
	According to the currently running linear velocity

4.5 Operation panel button is introduced

The keys	Name	Function
	Programming/exit key	Level 1 menu to enter or exit
	MK key(Multifunction button)	The key function defined by the parameter P50.03
	Identify key	Into the secondary menu, set parameter confirmation
	Increases the key	Increasing data or function code
	The reduction of key	Diminishing data or function code
	The shift key	Under the outage display interface and operation interface, can choose according to cycle parameters
	The operation key	Under the keyboard operation, used to run the operation
	Stop/reset button to	Running state, press this button can be used to stop running operation; Fault alarm state, can be used to copy operation.

4.6 The operation panel display status

NO.	According to the State	Instructions	The panel light
1	Stop parameter display state	By "  ", according to set parameters for choosing P50.09.	/
2	Operation parameters display status	Can switch by "  ", according to set parameters for choosing P50.10 and P50.11.	RUN: Bright FWD: Run a direction COMD: Indicating control run a command
3	The alarm parameters display status	Press "  " button to cycle according to running status parameters and alarm code.	ALM: Flashing
4	Fault parameters display status	Press "  " button to cycle according to running status parameters and alarm code.	ALM: Normally on
5	Level 1 menu	Any display mode, press the programming/exit key to	





NO.	According to the State	Instructions	The panel light
	display state	enter or exit	
6	The secondary menu display state	Into the level menu, press confirm button to enter or exit	

4.7 Keyboard

Parameter Settings:

Two levels of menu are:

1. Function block number and the function code label (menu)
2. Function code set value (secondary menu);

Description: In the secondary menu operation, can press the "  " key or"  "return to menu key, The difference is: Press "  " button to save setting parameters after return level menu, And automatically move to the next function code; And press "  " button directly return level menu, No storage parameters, and returns to the current function code.

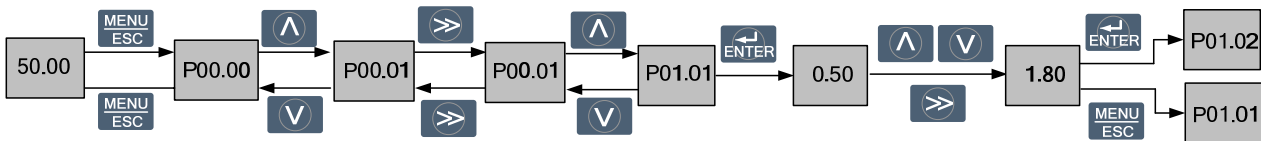

figure 4-3 Modify parameters schematic diagram

In any level 1 menu state, if the parameter is not flashing, said the function code cannot be modified, Possible reasons are:

- 1) This function code is not modify parameters. Such as the actual testing parameters, operation records, etc.;
- 2) The function code under running immutable, Need to stop after the operation can be modified

LED display function code parameter menu mode:

There are four kinds of MV series servo drive menu mode: Basic menu, senior menu, the user model and factory value comparison. By setting function code P50.01 switch parameters (menu mode), Different parameter mode, display the function of different parameter set.

How to set up the servo drive password:

In order to protect the parameter, frequency converter provides password protection function.

Set the user password, the user input user password must be correct, To press "  " button after entering the function code editor. For the factory area set parameters, still need to input the factory correct password.



When need the user password, set the P50.00 nonzero Numbers for any group, And click on the "  "key to confirm. If after this row 1 minutes without any key operation, the password protection function to take effect. After the correct input user password, if 1 minutes without keystrokes, password protection will give effective protection.



 **Pay attention to**

- ◆ Please do not attempt to modify the manufacturer set parameters, If the parameter Settings, easy to cause the servo drive work abnormal or even damage.

How to lock and unlock operation panel:

Through the function code P50.03 one thousand can set the lock operation panel.

In the condition of downtime parameter display, Press the ENTER key and maintain, then press “”key, LED display “” Lock operation panel.

When all operation panel button is locked, can be unlocked by the following: Press “” key and maintain, then press “” key three times.

 **Pay attention to**

- ◆ Whatever P50.03 before setting, servo drive every time after power on, the operation panel are not locked.

Asynchronous motor parameter self learning:

Choosing vector control operation mode, input motor nameplate parameters must be accurate, Frequency converter according to the nameplate parameters matching standard motor; In order to get good control performance, it is suggested that to motor parameter self learning and self learning steps are as follows:

First will run command channel (PO0.01) choice for keyboard commands; Then please click the parameters of the motor under the actual parameter input

P51.00	Encoder wiring harness (closed-loop vector control)
P60.00	Rated power
P60.01	Rated current
P60.02	The rated voltage
P60.03	Rated frequency
P60.04	Rated speed

If the motor shall not release the load, the P60.11 please select 1 (static setting), And then press “” button on the panel, and servo drive automatically measuring stator resistance and rotor resistance and leakage inductance in turn three parameters, Don't measure the mutual inductance and resistance of the motor no-load current, the user can according to the motor nameplate parameters to calculate the three parameters, Used in the calculation of the motor nameplate parameters are: rated voltage U, rated current, rated frequency f I eta, power factor, rated power and rated speed.

If it is the motor and load completely release P60.11 please select 2 (rotating self-tuning) And then press “” button on the panel, and servo drive will automatically calculate the motor parameters. In the process of self-learning, electricity opportunities slowly rolling, When the motor rotation after downtime, motor parameter since the end of the learning process.

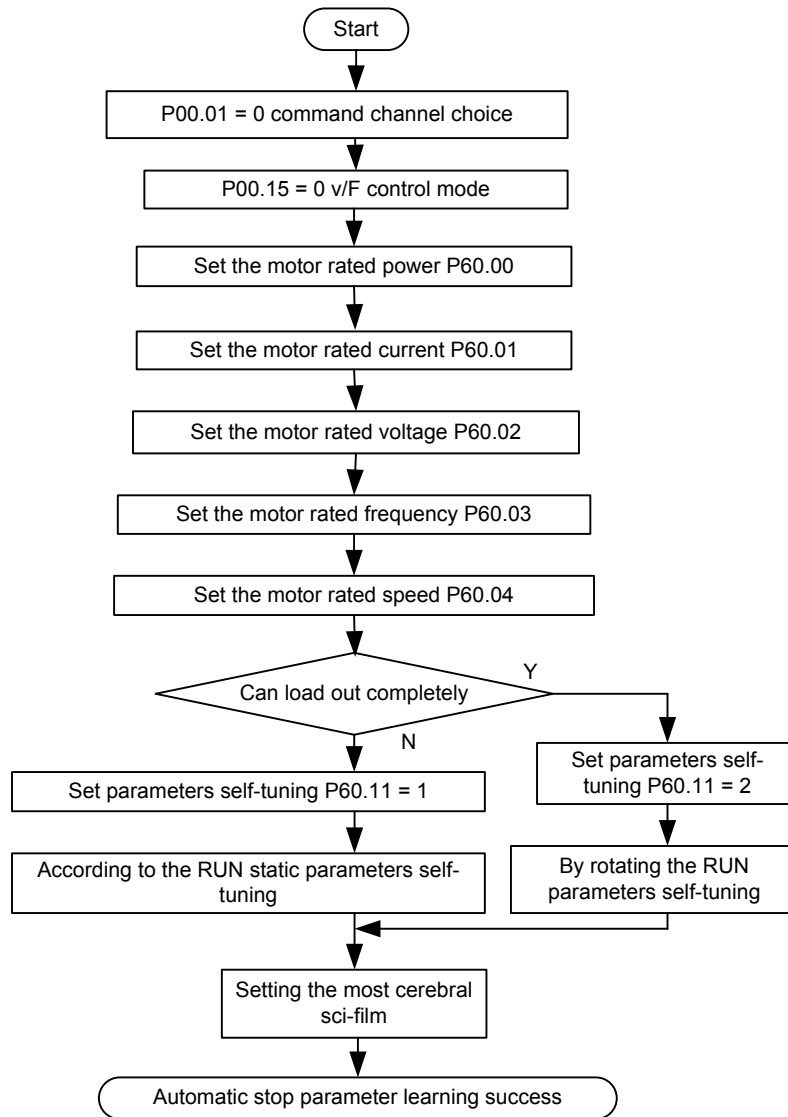

Figure 4-4 asynchronous motor self-tuning flow chart

Chapter 5 For the first time on electricity to run

Wiring and power check and correct, the input side converter ac power air switch to electricity, servo drive operation panel first shows "8.8.8.8.8."

The contactor is normal and When the digital tube display character into a set frequency, shows that servo drive is initialized.If the COMD LED indicator on the operation panel to light condition, suggests that for the operation panel control state.

Pay attention to

- ◆ In case of failure, please use chapter 7 faults and alarm information list judgment in reason, troubleshooting.
- ◆ If the motor can choose to release the load rotating self-tuning (P60.11 = 2), otherwise can only choose static self-tuning. Starting parameters from the timing, please ensure that the motor is in static state, in the process of the self-tuning if seen through the pressure failure, can be appropriately extended P00.07, P00.08 deceleration time.

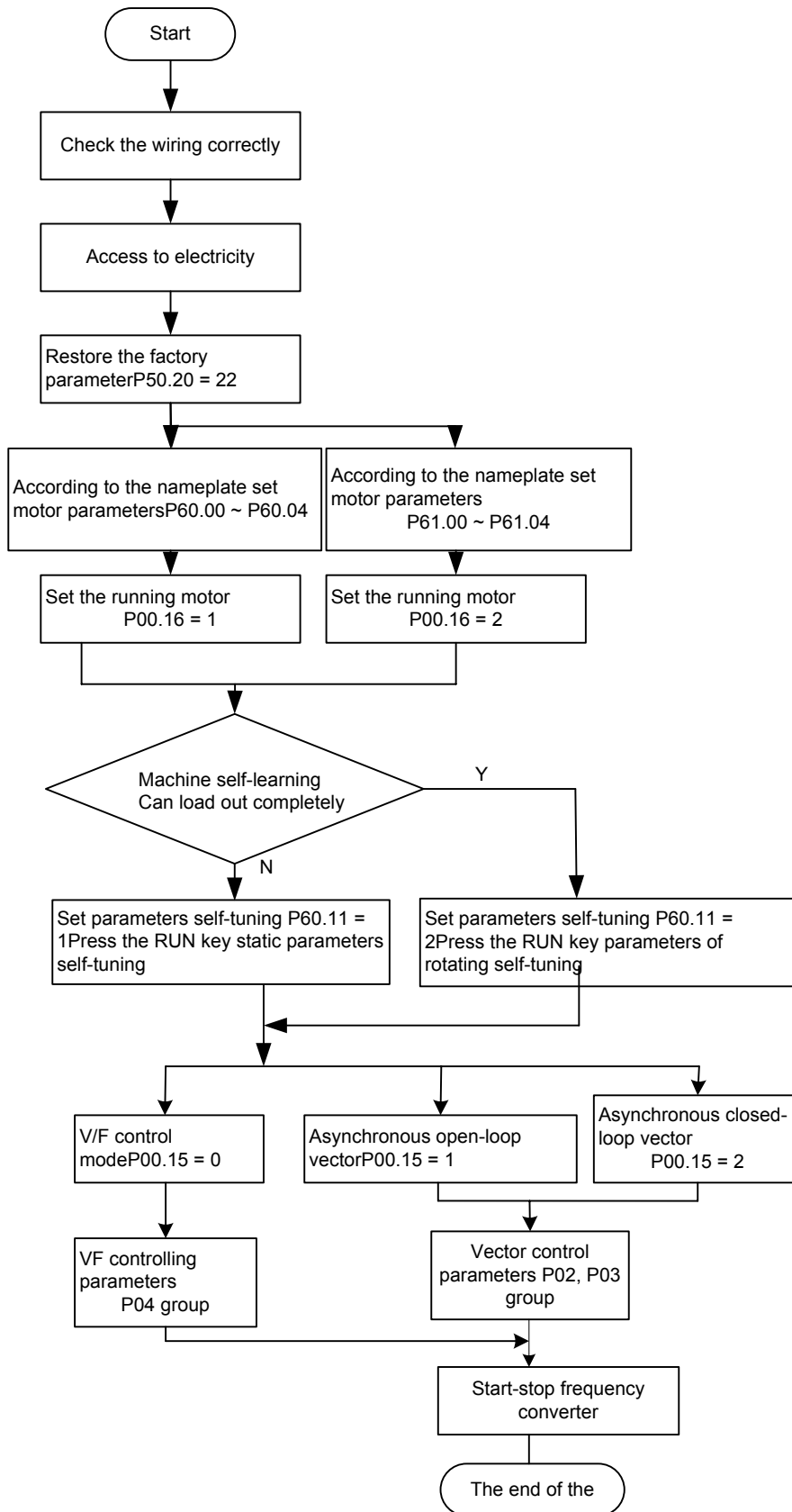

Figure 5-1 on electric operation flow chart for the first time

Chapter6 Function parameter profiles

Function code	Functions within the group number and group number, such as P01.02 is 01 group, 02 function code
Name of the function code	The name of the function code, explain the function of the function code
setting range	Function code minimum to the maximum effective set range
Factory	The factory setting of the function code
Parameters in detail	Parsing the meaning represented different function code parameter values
Unit	The unit of function code: V-voltage; A-current; Hz、KHz-frequency; rpm-Speed; KW-power; °C-temperature; ms、s、min、h、kh-time; %-percentage; bps-Baud rate; kgm/s ² -moment of inertia; /-No unit
change	Function code allows parameter change of conditions: ○-The parameter can be modified when the AC servo drive is in either stop or running state. ×-The parameter cannot be modified when the AC servo drive is in the running state. *-The parameter is the actually measured value and cannot be modified.
mailing address	Modbus and MXLink mailing address, In the table for hexadecimal display
Basic menu item	√-Basic menu contains the function code; ×-Basic menu does not contain the function code

Function code	Name of parameter	Set Range	Factory	Basic menu	change	mailing address
P00 The basic function parameters						
P00.00	Keypad set frequency	0.00~400.00	30.00	√	○	0000
P00.01	Command source selection	0: Operation panel control 1: Terminal control 2: Modbus/MXLink Communication control 3: Communication expansion card control	0	√	○	0001
P00.02	A frequency Command	0: Keypad (P00.00 Set frequency by Keypad) 1: AI1 2: AI2 3: AI3 4: Pulse setting (DI)	0	√	○	0002
P00.03	B frequency Command	5: Simple PLC 6: Multi-reference 7: PID 8: Modbus/MXLink Communication setting 9: Communication expansion card	1	×	○	0003
P00.04	B frequency Command Reference	0: Maximum output frequency , 100% of B Frequency setting corresponds to the maximum output frequency	0	×	○	0004

Function code	Name of parameter	Set Range	Factory	Basic menu	change	mailing address
		1: A frequency Command, 100% of B Frequency setting corresponds to the maximum output frequency , Select this setting if needs				
P00.05	Combination of the setting	0: A , the current frequency setting is A frequency Command 1: B , the current frequency setting is B frequency Command 2: A+B, the current frequency setting is A frequency command+ B frequency command 3: A-B, the current frequency setting is A frequency command- B frequency command 4:Max(A, B):The bigger one between A frequency command and B frequency is the set frequency 5: Min(A, B):The lower one between A frequency	0	×	○	0005
P00.06	Running direction	0: forward 1: reverse	0	×	○	0006
P00.07	Acceleration time 1	0.1~3600.0	6.0	√	○	0007
P00.08	Deceleration time 1	0.1~3600.0	6.0	√	○	0008
P00.09	keep					0009
P00.10	keep					000A
P00.11	Maximum output frequency	Max(50.00, P00.12)~400.00	50.00	×	×	000B
P00.12	Frequency lower limit	0.00~P00.13(Frequency upper limit)	0.00	×	×	000C
P00.13	Frequency upper limit	P00.12(Frequency lower limit) ~ P00.13(Frequency upper limit)	50.00	×	×	000D
P00.14	Running operation frequency	0.01~60.00	5.00	×	○	000E
P00.15	control mode	Unit's digit (FMR valid mode): Motor 1 control mode 0: V/F control mode 1: Asynchronous open-loop vector 2: Asynchronous closed-loop vector 3: Synchronous closed-loop vector 4: Synchronous open-loop vector Ten's digit (Relay 1 valid mode: Motor 2 control mode Same as above	0x00	√	×	000F
P00.16	motor selection	0: Motor 1 1: Motor 2	1	×	×	0010
P01 Start-stop control parameters						

Function code	Name of parameter	Set Range	Factory	Basic menu	change	mailing address
P01.00	Start mode	0: Stal,t-up directly:stallfrom the staltil'lg freoluenGy P01.01 1: Stal,t-up after DC braking 2: Rotational speed tracking restart	0	√	×	0100
P01.01	Startup frequency	0.00~60.00	0.50	×	×	0101
P01.02	Startup frequency holding time	0.00~600.00	0.00	×	×	0102
P01.03	Startup DC braking current Pre-excited current	0.0~100.0	50.0	×	×	0103
P01.04	Startup DC braking time Pre-excited time	0.00~30.00	0.00	×	×	0104
P01.05	Stop mode	0: Decelerate to stop 1: Coast to stop	0	√	×	0105
P01.06	Initial frequency of stop DC braking	0.00~60.00	1.00	×	×	0106
P01.07	Waiting time of stop DC braking	0.00~10.00	0.00	×	×	0107
P01.08	Stop DC braking current	0.0~100.0	50.0	×	×	0108
P01.09	Stop DC braking time	0.00~30.00	0.00	×	×	0109
P01.10	Anti-reverse choice	0: Allow the reversal 1: Ban reversal	0	×	×	010A
P01.11	Forward/Reverse rotation dead-zone time	0.00~600.00	0.00	×	×	010B
P01.12	Shifting between FWD/REV rotation	0: Switch after zero frequency 1: Switch after the starting frequency	0	×	×	010C
P01.13	Restart after power off	0: Ddisable 1: Enable	0	×	×	010D
P01.14	The waiting time of Restart	0.00~60.00	0.00	×	×	010E

Function code	Name of parameter	Set Range	Factory	Basic menu	change	mailing address
	after power off					
P01.15	Stopping speed	0.00~60.00	0.10	×	×	010F
P01.16	Detection of stoppoing speed	0: Detect according to speed setting (no stopping delay) 1: Detect according to speed feedback (only valid for vector control)	0	×	×	0110
P01.17	Detection time of feedback speed	0.00~10.00	0.05	×	×	0111
P01.18	Tining stopping time	0.00~650.00	0.00	×	○	0112
P01.19	Timing stopping set	Unit's digit: stopping tine gallery 0: Tining stopping time P01.18 1: AI1 2: AI2 3: AI3 AI 100%Correspond to the time P01.18 Ten's digit: unit of stopping tine 0: s 1: min 2: h Hundred's digit: timer stop action keep 0: stoping, timer reset 1: stoping, timer keep Pay attention: timer time arrive, time constraint Reset	0X000	×	○	0113
P01.20	Running time preset values	0.00~650.00	0.00	×	○	0114
P01.21	Frequency lower limit operation mode	0~1	0	×	×	0115
P01.22	suspension detection delay of Frequency lower limit	0.000~60.000	0.100	○	×	0116
P02 Vector control parameters						
P02.00	Speed loop proportional gain 1(High speed) (ASR1-Kp)	0.00~100.00	20.00	√	○	0200

Function code	Name of parameter	Set Range	Factory	Basic menu	change	mailing address
P02.01	Speed loop integral time 1 (High speed) (ASR1-Ti)	0.000~10.000	0.200	√	○	0201
P02.02	Switchover frequency 1	P02.05(ASR2 Switchover frequency) ~ P00.11(MXM frequency of output)	10.00	×	○	0202
P02.03	Speed loop integral time 2 (low speed)(ASR2-Ti)	0.00~100.00	20.00	√	○	0203
P02.04	Speed loop integral time 1 (low speed) (ASR2-Ti)	0.000~10.000	0.200	√	○	0204
P02.05	ASR2 Switchover frequency 2	0.00~P02.02 (ASR1 Switchover frequency 2)	5.00	×	○	0205
P02.06	Speed loop output filter	0.000~0.100	0.000	×	○	0206
P02.07	Electromotion torque set	0.0~300.0	180.0	×	○	0207
P02.08	Upper braking torque astrict set	0.0~300.0	180.0	×	○	0208
P02.09	Current loop percentage coefficient	0.001~2.000	1.000	×	○	0209
P02.10	Current loop integral coefficient	0.1~500.0	10.0	×	○	020A
P02.11	Pre-exciting time	0.00~10.00	0.30	×	×	020B
P02.12	Pre-exciting current	50.0~200.0	100.0	×	×	020C
P02.13~P02.15	Keep					
P02.16	Compensation coefficient of electromotion slip	10.0~300.0	100.0	×	○	0210
P02.17	Compensation coefficient of braking slip	10.0~300.0	100.0	×	○	0211
P03 Torque control parameters						
P03.00	torque /speed	0: speed control 1: torque control	0	√	○	0300

Function code	Name of parameter	Set Range	Factory	Basic menu	change	mailing address
	control					
P03.01	Given torque figures	-300.0~300.0	0.0	×	○	0301
P03.02	Torque setting method	0: Keypad setting torquen P03.01 1: Analog AI1 setting troque 2: Analog AI2 setting troque 3: Analog AI3 setting troque 4: Pulse frequency HDI setting torque 5: PID output 6: Modbus/MXLink communication setting torque 7: PLC Extension control card setting torque	0	×	○	0302
P03.03	Torque reference filter time	0.000~60.000	0.100	×	○	0303
P03.04	Torque proportionality coefficient set	0.000~3.000	0.100	×	○	0304
P03.05	Upper frequency of forward rotation in vector control	0: Keypad setting torquen P02.07 1: Analog AI1 setting troque 2: Analog AI2 setting troque 3: Analog AI3 setting troque 4: Pulse frequency HDI setting torque 5: PID output 6: Modbus/MXLink communication setting torque 7: PLC Extension control card setting torque	0	×	○	0305
P03.06	Upper frequency of reverse rotation in vector control	0: Keypad setting torquen P02.08 1: Analog AI1 setting troque 2: Analog AI2 setting troque 3: Analog AI3 setting troque 4: Pulse frequency HDI setting torque 5: PID output 6: Modbus/MXLink communication setting torque 7: PLC Extension control card setting torque	0	×	○	0306
P03.07	Torque limit ratio	0.000~3.000	2.000	×	○	0307
P03.08	Forward maximum frequency gallery	0: Keypad setting P03.10 1: Analog AI1 setting 2: Analog AI2 setting 3: Analog AI3 setting 4: Pulse frequency HDI setting 5: PID output 6: Modbus/MXLink communication setting 7: PLC Extension control card setting	0	×	○	0308
P03.09	REV maximum	0: Keypad setting P03.10	0	×	○	0309

Function code	Name of parameter	Set Range	Factory	Basic menu	change	mailing address
	frequency gallery	1: Analog AI1 setting 2: Analog AI2 setting 3: Analog AI3 setting 4: Pulse frequency HDI setting 5: PID output 6: Modbus/MXLink communication setting 7: PLC Extension control card setting				
P03.10	Forward maximum frequency	0.0~100.0	100.0	×	○	030A
P03.11	REV maximum frequency	0.0~100.0	100.0	×	○	030B
P03.12	Coefficient of friction compensation	0.00~20.00	0.00	×	○	030C
P03.13	Torque offset number given	-100.0~100.0	0.0	×	×	030D
P04 V/F control parameters						
P04.00	V/F curve setting	0: Linear V/F 1: Multi-point V/F 2~11: 1.1~2.0Power down torqueV/F 12: V/F complete separation	0	√	×	0400
P04.01	V/F frequency f1	0.00~P04.03(V/F frequency f2)	0.00	×	×	0401
P04.02	V/F voltage V1	0.0~P04.04(V/F voltage V2)	0.0	×	×	0402
P04.03	V/F frequency f2	P04.01(V/F frequency f1)~P04.05(V/F frequency f3)	0.00	×	×	0403
P04.04	V/F voltage V2	P04.02(V/F voltage V1)~P04.06(V/F voltage V3)	0.0	×	×	0404
P04.05	V/F frequency f3	P04.03(V/F frequency f2)~P04.07(V/F frequency f4)	0.00	×	×	0405
P04.06	V/F voltage V3	P04.04(V/F voltage V2)~P04.08(V/F voltage V4)	0.0	×	×	0406
P04.07	V/F frequency f4	P04.05(V/F frequency f3)~P00.11(Maximum output frequency)	0.00	×	×	0407
P04.08	V/F voltage V4	P04.06(V/F voltage V3)~100.0	0.0	×	×	0408
P04.09	AVR function	0: forbid AVR 1: enable AVR	1	×	×	0409
P04.10	Torque compensation	0.0: AUTO Torque compensation 0.1~30.0: Manual Torque compensation	0.0	×	○	040A
P04.11	Cut-off frequency of torque boost	0.0~100.0	100.0	×	○	040B
P04.12	V/F slip	0.0~200.0	100.0	×	○	040C

Function code	Name of parameter	Set Range	Factory	Basic menu	change	mailing address
	compensation gain					
P04.13	V/F slip compensation Limit	0.0~300.0	200.0	×	○	040D
P04.14	V/F slip compensation Prop filter	0.001~10.000	2.000	×	○	040E
P04.15	V/F oscillation suppression gain	0.00~10.00	1.00	×	○	040F
P04.16	V/F Separation set	<p>units' digit: After downtime command voltage set value</p> <p>0: Given the output voltage value of the minimum voltage P04.22</p> <p>1: Voltage to maintain set the channel set value ten, hundred, thousand: keep</p>	0x00	×	×	0410
P04.17	Voltage source for V/F separation	<p>0: Keypad setting P04.18</p> <p>1: Analog AI1 setting</p> <p>2: Analog AI2 setting</p> <p>3: Analog AI3 setting</p> <p>4: Pulse frequency HDI setting</p> <p>5: keep</p> <p>6: PID output</p> <p>7: Modbus/MXLink communication setting</p> <p>8: PLC Extension control card setting</p>	0	×	○	0411
P04.18	Voltage digital setting for V/F separation	0.0~100.0	0.0	×	○	0412
P04.19	Voltage rise time of V/F separation	0.1~3600.0	6.0	×	○	0413
P04.20	Voltage decline time of V/F separation	0.1~3600.0	6.0	×	○	0414
P04.21	Maximum output voltage	P04.22(Minimum output voltage)~100.0	100.0	×	×	0415
P04.22	Minimum output voltage	0.0~P04.21(Maximum output voltage)	0.0	×	×	0416
P05 Frequency of auxiliary parameters						
P05.00	Auxiliary frequency	<p>0: keypad \wedge \vee set</p> <p>1: terminal UP/DN set</p>	0	×	○	0500

Function code	Name of parameter	Set Range	Factory	Basic menu	change	mailing address
	source selection	2: keep				
P05.01	Auxiliary frequency control	units' digit: 0: Frequency power storage 1: Frequency power no store ten's digit: 0: Auxiliary frequency trimming stop is adjustable 1: Auxiliary frequency tuning is adjustable in the run, only stop keeping 2: Assisted in the operation of the frequency tuning is adjustable, Stop reset The above function applies only to P05.00 of 0 and 1	0x00	×	○	0501
P05.02	Run the command channel bundling frequency channel	units' digit: Operation panel control command 0: No bound 1: Keypad setting P04.18 2: Analog AI1 setting 3: Analog AI2 setting 4: Analog AI3 setting 5: Pulse frequency HDI setting 6: Simple PLC 7: multi-speed 8: PID 9: Modbus/MXLink communication setting 10: PLC Extension control card setting Ten' digit: Terminal command control ditto hundred's: Modbus/MXLink command control ditto Thousand digit: Command and control communications extension card ditto	0x0000	×	○	0502
P05.03	Linear velocity coefficient	0.1~400.0	1.0	×	○	0503
P05.04	Keyboard digital potentiometer Settings	units' digit: Digital potentiometer scope 0: Only for frequency fine tuning 1: Frequency fine tuning, and the contents of the function code 2: The frequency tuning and the contents of the function code and selection function code sequence number ten's digit: 0: Digital potentiometer initial step 0.01 1: Digital potentiometer initial step 0.10 2: Digital potentiometer initial step 1.00 3: Digital potentiometer initial step 10.00	0x02	×	○	0504
P05.05	Jump frequency	0.00~400.00	0.00	×	×	0505

Function code	Name of parameter	Set Range	Factory	Basic menu	change	mailing address
	1					
P05.06	Frequency 1 jump amplitude	0.00~30.00	0.00	×	×	0506
P05.07	Jump frequency 2	0.00~400.00	0.00	×	×	0507
P05.08	Frequency 2 jump amplitude	0.00~30.00	0.00	×	×	0508
P05.09	Jump frequency 3	0.00~400.00	0.00	×	×	0509
P05.10	Frequency 3 jump amplitude	0.00~30.00	0.00	×	×	050A
P05.11	Keep					050B
P06 Deceleration parameters						
P06.00	Acceleration time 2	0.1~3600.0	6.0	×	○	0600
P06.01	Deceleration time 2	0.1~3600.0	6.0	×	○	0601
P06.02	Acceleration time 3	0.1~3600.0	6.0	×	○	0602
P06.03	Deceleration time 3	0.1~3600.0	6.0	×	○	0603
P06.04	Acceleration time 4	0.1~3600.0	6.0	×	○	0604
P06.05	Deceleration time 4	0.1~3600.0	6.0	×	○	0605
P06.06	Frequency switchover point between acceleration time 1 and acceleration time 2	0.00~400.00	0.00	×	○	0606
P06.07	Frequency switchover point between deceleration time 1 and deceleration time 2	0.00~30.00	1.00	×	○	0607
P06.08	S curve of time start to accelerate	0.0~10.0	0.0	×	×	0608
P06.09	Accelerate the	0.0~10.0	0.2	×	×	0609

Function code	Name of parameter	Set Range	Factory	Basic menu	change	mailing address
	end time of S curve					
P06.10	Slow start S curve	0.0~10.0	0.2	×	×	060A
P06.11	End S curve time reduction	0.0~10.0	0.0	×	×	060B
P06.12	JOG acceleration time	0.1~60.0	6.0	×	○	060C
P06.13	JOGdeceleration time	0.1~60.0	6.0	×	○	060D
P06.14	JOG interval time	0.0~100.0	0.0	×	○	060E
P06.15	Emergency stop deceleration time	0.0~6000.0	1.0			060F
P07 Control enhancement parameters						
P07.00	carrier frequency	1.0~15.0	8.0	×	○	0700
P07.01	SVPWM modulation parameter	units' digit: Carrier adjust themselves according to the temperature inside the machine 0: ban 1: enabled Carrier frequency automatically adjust action selection, servo drive can adjust automatically according to the temperature inside the machine to the carrier frequency. ten's digit: PWM modulation output 0: ban 1: enabled When the input power is low, the PWM modulation can improve the busbar voltage utilization ratio, to maintain the output voltage, output of motor.	0x0011	×	○	0701
P07.02	The open loop vector model	0: mode 1,Better steady speed precision 1: mode 2,Lower speed pulsation	0	×	×	0702
P07.03	energy-saving operation	0: orbid 1: enabled	0	×	○	0703
P07.04	V/F running coefficient	0.0~50.0	30.0	×	○	0704
P07.05	Keep					0705
P07.06	Keep					0706
P07.07	Automatic current limiting options	0: Effective acceleration and deceleration, constant speed is invalid 1: Deceleration, constant speed are effective 2: constant speed, acceleration and deceleration are	1	×	×	0707

Function code	Name of parameter	Set Range	Factory	Basic menu	change	mailing address
		invalid				
P07.08	Automatic current limit levels	50.0~200.0	160.0	×	×	0708
P07.09	V/F current limit control gain	0.00~10.00	1.00	×	○	0709
P07.10	Function of overpressure stall	0: orbid 1: enabled	0	×	×	070A
P07.11	Stall point overvoltage	640~780	750	×	×	070B
P07.12	Over-excitation deceleration function	0: No Operation 1: Inhibition of busbar voltage over-voltage, don't over excitation control 2:Inhibition of busbar voltage over-voltage, and excitation control	2	×	×	070C
P07.13	Overvoltage suppression detection value	680~740	720	×	×	070D
P07.14	Instantaneous stop function	0.000~4.000	1.000	×	○	070E
P07.15	Instantaneous stop function	0: orbid 1: enabled	0	×	×	070F
P07.16	Instantaneous stop detection value	400~480	450	×	×	0710
P07.17	Instantaneous stop deceleration gain	0.000~4.000	1.000	×	○	0711
P07.18~ P07.21	Keep					0712~0715
P07.22	The droop control gain	0.0~100.0	0.0	×	○	0716
P07.23	Droop control filtering time	0.01~5.00	0.50	×	○	0717
P08 Speed and torque protection parameters						
P08.00	Detection value of too large speed deviation	0.0~50.0	30.0	×	×	0800
P08.01	Detection time of too large speed deviation	0.0~60.0	10.0	×	×	0801

Function code	Name of parameter	Set Range	Factory	Basic menu	change	mailing address
P08.02	Speed deviation is too large to protect	units' digit: Check out the selection 0: Non detection 1: Only in constant speed detection 2: Has been detected ten's digit: alarm select 0: Free downtime and failure 1: Alarm and continue running	0x00	×	×	0802
P08.03	Rapid detection threshold	0.0~150.0	110.0	×	×	0803
P08.04	Rapid detection of time	0.000~2.000	0.010	×	×	0804
P08.05	Rapid protection action	units' digit: Check out the selection 0: Non detection 1: Only in constant speed detection 2: Has been detected ten's digit: alarm select 0: Free downtime and failure 1: Alarm and continue running	0x00	×	×	0805
P08.06	Torque is insufficient or big protections	units' digit: Check out the selection (1) protection 0: Non detection 1: Detect torque is too big 2: Only in the constant speed test torque is too big 3: Torque measurement is insufficient 4: Only in the constant speed test torque ten's digit: alarm select 0: Free downtime and failure 1: Alarm and continue running hundred's digit: Check out the selection (1) protection 0: Non detection 1: Detect torque is too big 2: Only in the constant speed test torque is too big 3: Torque measurement is insufficient 4: Only in the constant speed test torque Thousand's digit: alarm select 0: Free downtime and failure 1: Alarm and continue running	0x0000	×	×	0806
P08.07	Torque is insufficient/big detection threshold 1	0.0~200.0	30.0	×	×	0807
P08.08	Torque is insufficient/big checkout time 1	0.0~60.0	10.0	×	×	0808

Function code	Name of parameter	Set Range	Factory	Basic menu	change	mailing address
P08.09	Torque is insufficient/big detection threshold 2	0.0~200.0	30.0	×	×	0809
P08.10	Torque is insufficient/big checkout time 2	0.0~60.0	10.0	×	×	080A
P08.11	keep			×	×	080B
P09 Protect the parameter Settings						
P09.00	Option 1 protection action	units' digit: Abnormal communication action choice 0: Protection movement and free parking 1: The alarm and continues to run ten's digit: Brake pipe abnormal action choice 0: Protection movement and free parking 1: The alarm and continues to run 2: no detect hundred's digit: EEPROMAbnormal action choice 0: Protection movement and free parking 1: The alarm and continues to run	0x101	×	×	0900
P09.01	Option 2 protection action	units' digit: input phase action choice 0: failure to actuate 1: Protection movement and free parking 2: The alarm and continues to run ten's digit: output phase action choice 0: failure to actuate 1: Protection movement and free parking 2: The alarm and continues to run hundred's digit: Temperature detection circuit fault 0: failure to actuate 1: Protection movement and free parking 2: The alarm and continues to run Thousand's digit: In the operation of busbar undervoltage fault movements 0: failure to actuate 1: Protection movement and free parking	0x1111	×	×	0901
P09.02	Fault indicator selection	units' digit: Under-voltage fault indicator action choice 0: failure to actuate 1: Protection movement and free parking ten's digit: Automatic reset interval fault indicator action choice 0: Fault locking function allows, but no action	0x000	×	×	0902

Function code	Name of parameter	Set Range	Factory	Basic menu	change	mailing address
		instructions 1: Fault locking action and action hundred's digit: Fault locking action choice 0: Fault locking function is prohibited, but the instructions action 1: Fault locking function is prohibited, but no action instructions 2: Fault locking and direct action				
P09.03	alarm frequency set	0: alarm frequency given is invalid 1: alarm standby frequency(P09.04) 2: The current running frequency * alarm frequency coefficients(P09.05) 3: P00.00 set frequency 4: lower rate limit 5: upper limiting frequency	0	×	×	0903
P09.04	alarm standby frequency	0.00~400.00	1.00	×	×	0904
P09.05	alarm frequency coefficient	0.0~100.0	100.0	×	×	0905
P09.06	Fault auto reset times	0~100	0	×	×	0906
P09.07	Time interval of fault auto reset	1.0~60.0	5.0	×	×	0907
P09.08	Overload forecasting warning detection Settings	units' digit: Overload warning detection Settings 0: no detect 1: Has been testing 2: Only constant speed detection ten's digit: Underload early warning detection Settings 0: no detect 1: Has been testing 2: Only constant speed detection hundred's digit: alarm select 0: Underload were warning, continue to run 1: Underload warning continues to run, overload protection and free parking 2:Overload alarms continues to run, underload protection and free parking 3:Underload fault protection actions and free parking Thousandd's digit: Check out the amount of choice 0: Relative to the motor rated current 1: Relative frequency converter rated current	0x0000	×	×	0908

Function code	Name of parameter	Set Range	Factory	Basic menu	change	mailing address
P09.09	Overload forecasting warning detection levels	P09.11~200.0	130.0	×	×	0909
P09.10	Overload forecasting warning detection time	1.0~60.0	5.0	×	×	090A
P09.11	Off load detection levels	0.0~P09.08	30.0	×	×	090B
P09.12	Off load detection time	1.0~60.0	5.0	×	×	090C
P09.13	Output current limit alarm detection time	0.0~120.0	5.0	×	×	090D
P09.14	Output current limiting fault detection duration	0.0~600.0	60.0	×	×	090E
P09.15	Three-phase input imbalance	0.0~300.0	100.0	×	×	090F
P09.16	keep					0910
P10 Switch input parameters						
P10.00	Terminal status effectively	Bit0~Bit7: X1~X8 0: positive logic 1: negative logic	0x00	×	○	0A00
P10.01	Terminal starting protection option	0: Protection is invalid, enter the running state starting motor servo drive 1: Effective protection, frequency converter does not respond to the start command, must run a command to cancel first, and then run making effective, so that the frequency converter into the running state	1	×	×	0A01
P10.02	X1 terminal function	0: No function 1: Three-line control	6	√	×	0A02
P10.03	X2 terminal function	2: Command to switch to the keyboard 3: Command to switch to the terminals	7	√	×	0A03
P10.04	X3 terminal function	4: Command to switch to Modbus/MXLink 5: Command to switch to extend communication card	17	√	×	0A04
P10.05	X4 terminal function	6: Forward RUN (FWD) 7: Reverse RUN (REV)	18	√	×	0A05
P10.06	X5 terminal function	8: Forward JOG 9: Reverse JOG	12	√	×	0A06

Function code	Name of parameter	Set Range	Factory	Basic menu	change	mailing address
P10.07	X6 terminal function	10: External downtime (press down way down) 11: Coast to stop	42	×	×	0A07
P10.08	X7 terminal function	12: Fault reset (RESET) 13: RUN pause	0	×	×	0A08
P10.09	X8 terminal function	14: shift between A seting and B setting 15: shift between combination seting and A setting 16: shift between combination seting and B setting 17: Terminal UP 18: Terminal DOWN 19: Auxiliary setting frequency reset 20: Terminal 1 for acceleration/deceleration time selection 21: Terminal 2 for acceleration/deceleration time selection 22: Acceleration/Deceleration prohibited 23: pre-magnetized command 24: starting DC braking 25: stop DC braking 26: Multi-reference terminal 1 27: Multi-reference terminal 2 28: Multi-reference terminal 3 29: Multi-reference terminal 4 30: Multi-reference pause	0	×	×	0A09
		31: keep 32: PLC Stop memory clear 33: Simple PLC pause 34: PID control pause 35: PID Integral pause 36: PID Reverse PID action direction 37: PID Integra cleer 38: Multi-reference closed-loop terminal 1 39: Multi-reference closed-loop terminal 2 40: Multi-reference closed-loop terminal 3 41: Multi-reference closed-loop terminal 4 42: Swing pause 43: Swing reset 44: Speed/torque control switch control 45: keep 46: External fault input 47: External fault input 48: Motors 1, 2, select switch 49: Counter input(<200Hz) 50: Counter keep				

Function code	Name of parameter	Set Range	Factory	Basic menu	change	mailing address
		51: Counter clear 52: Auxiliary frequency is invalid 53: Frequency jog 54: Emergency stop 55: PID parameter switchover 56: Running time pause 57: Running time clear 58: S curve deceleration banned 59: keep 60: High-speed pulse input(DI) 61~95: keep				
P10.10	Terminal command mode	0: Two-line mode 1 1: Two-line mode 2 2: Three-line mode 1 3: Three-line mode 2	0	×	×	0A0A
P10.11	Terminal UP rate	0.01~50.00	1.00	×	○	0A0B
P10.12	Terminal DOWN rate	0.01~50.00	1.00	×	○	0A0C
P10.13	Preset count value given	1~P10.14	10	×	×	0A0D
P10.14	To count the given	P10.13~60000	20	×	×	0A0E
P10.15	Terminal count preassigned frequency	1~65535	1	×	×	0A0F
P10.16	Terminal count configuration	units' digit: Count the input terminals 0: Count the input is not action 1: Ordinary Terminal (X1~X8)200Hz 2: High speed input terminals(X8) ten's digit: trigger edge 0: Rising edge the effective 1: Falling edge effectively 2: Rising edge and Falling edge are effective hundred's digit: Stop counting reset option 0: Stop count value reduction 1: Stop continue to count Thousand's digit: Terminal count reaches the action 0: No action 1: Produce halt command 2: Reset the count 3: Reset the count value and generate stop command	0x0000	×	×	0A10

Function code	Name of parameter	Set Range	Factory	Basic menu	change	mailing address
P10.17	Maximum input pulse frequency	0.1~80.0	10. 0	×	○	0A11
P10.18	Pulse filter time is given	0.001~9.999	0.010	×	○	0A12
P10.19	Pulse center model	0: No center 1: Center pattern 1 2: Center mode 2	0	×	×	0A13
P10.20	Keep					
P10.21	Keep					
P10.22	Switch- on delay of X1 terminal	0.000~60.000	0.010	×	○	0A16
P10.23	Switch- on delay of X2 terminal	0.000~60.000	0.010	×	○	0A17
P10.24	Switch- on delay of X3 terminal	0.000~60.000	0.010	×	○	0A18
P10.25	Switch- on delay of X4 terminal	0.000~60.000	0.010	×	○	0A19
P10.26	Switch- on delay of X5 terminal	0.000~60.000	0.010	×	○	0A1A
P10.27	Switch- on delay of X6 terminal	0.000~60.000	0.010	×	○	0A1B
P10.28	Switch- on delay of X7 terminal	0.000~60.000	0.010	×	○	0A1C
P10.29	Switch- on delay of X8 terminal	0.000~60.000	0.010	×	○	0A1D
P10.30	Switch- off delay of X1 terminal	0.000~60.000	0.010	×	○	0A1E
P10.31	Switch- off delay of X2 terminal	0.000~60.000	0.010	×	○	0A1F
P10.32	Switch- off delay of X3 terminal	0.000~60.000	0.010	×	○	0A20
P10.33	Switch- off delay of X4 terminal	0.000~60.000	0.010	×	○	0A21
P10.34	Switch- off delay of X5 terminal	0.000~60.000	0.010	×	○	0A22
P10.35	Switch- off delay of X6 terminal	0.000~60.000	0.010	×	○	0A23
P10.36	Switch- off delay of X7 terminal	0.000~60.000	0.010	×	○	0A24
P10.37	Switch- off delay of X8 terminal	0.000~60.000	0.010	×	○	0A25
P11 Switch output parameters						

Function code	Name of parameter	Set Range	Factory	Basic menu	change	mailing address
P11.00	Output terminal set effective operation	Bit0~Bit3: Y1、 Y2、 BR、 TR Relay 0: positive logic 1: negative logic	0x000F	×	○	0B00
P11.01	Y1 output terminals function selection	0: AC servo drive running 1: Motor and reversing instructions 2: Frequency reached 3: Frequency-level detection	0	√	○	0B01
P11.02	R function of relay selection	FDT1 output 4: Frequency-level detection	14	√	○	0B02
P11.03	T function of relay selection	FDT2 output 5: Zero-speed running (no output at stop)	15	×	○	0B03
P11.04	Y2/DO output terminals function selection	6: Frequency upper limit reached 7: Frequency lower limit reached 8: Motor overload pre-warning 9: Motor underload pre-warning 10: Current limit alarm output 11: Customize the alarm output 12: under voltage blocking 13: External downtime 14: servo drive alarm 15: Servo drive fault 16: Ready for RUN 17: completion of simple plc stage 18: completion of simple plc cycle 19: setting count value arrival 20: defined count value arrival 21: Modbus/MXLink control 22: Expand communication card control action 23: Closed-loop detection 24: closed-loop feedback low threshold detection 25: closed-loop feedback high threshold detection 26: Timing shutdown time 27: Running time presets to action 28~31: keep 32: AO1 analog detection action 1 33: AO1 analog detection action 2 34: AO2 analog detection action 1 35: AO2 analog detection action 1 36: VAO1 analog detection action 1 37: VAO1 analog detection action 2 38: VAO1 analog detection action 3 39: VAO2 analog detection action 1 40: VAO2 analog detection action2	2	×	○	0B04

Function code	Name of parameter	Set Range	Factory	Basic menu	change	mailing address
		41: VAO2 analog detection action 3 42: VAO3 analog detection action 1 43: VAO3 analog detection action 2 44: VAO3 analog detection action 3 45: A torque/owe early warning detection 1 torque 46: A torque/owe early warning detection 2 torque 47: torque control frequency limit 48: torque control torque limit 49~63: Keep Y2/DO Output terminal function selection: 64: output frequency 65: set frequency 66: Output current (relative 2 times the rated current of transducers) 67: Output current (relative 2 times the motor rated current) 68: Output voltage 69: busbar voltage 70: Output torque 71: keep 72: exciting flux 73: Output speed 74: output power 75: Cumulative frequency converter overloading 76: Motor overload the cumulative 77: Temperature of the servo drive 78: temperature of the rectifier 79: PC percentage 80: PID setting 81: PID Feedback 82: PID Input bias 83: PID output 84: Analog input AI1 85: Analog input AI2 86: Analog input AI2 87: After the adjustment AI1 88: After the adjustment AI2 89: After the adjustment AI3 90: High-speed pulse input frequency 91: Set torque 92: Extend communication card set value 93~95: keep				

Function code	Name of parameter	Set Range	Factory	Basic menu	change	mailing address
P11.05	Frequency to check out the width	0.00~200.00	2.50	×	○	0B05
P11.06	Zero speed operation thresholds	0.00~10.00	0.50	×	○	0B06
P11.07	FDT1 Upper bounds of the level	P11.08~400.00	50.00	×	○	0B07
P11.08	FDT1 lower bounds of the level	0.00~P11.07	49.00	×	○	0B08
P11.09	FDT2 Upper bounds of the level	P11.10~400.00	25.00	×	○	0B09
P11.10	FDT2 lower bounds of the level	0.00~P11.09	24.00	×	○	0B0A
P11.11	highest frequency pulse output	0.1~80.0	10.0	×	○	0B0B
P11.12	Pulse output filtering time	0.001~9.999	0.010	×	○	0B0C
P11.13	Action 1 low simulation detection	0.0~P11.14	20.0	×	○	0B0D
P11.14	Analog detection action 1 high value	P11.13~100.0	100.0	×	○	0B0E
P11.15	Action 2 low simulation detection	0.0~P11.16	40.0	×	○	0B0F
P11.16	Analog detection action 2 high value	P11.15~100.0	100.0	×	○	0B10
P11.17	Action 3 low simulation detection	0.0~P11.18	60.0	×	○	0B11
P11.18	Analog detection action 3 high value	P11.17~100.0	100.0	×	○	0B12
P11.19	Custom alarm	0~20	0	×	○	0B13

Function code	Name of parameter	Set Range	Factory	Basic menu	change	mailing address
	output alarm code					
P11.20 ~ P11.23	Keep					
P11.24	Y1 output terminals close time delay	0.000~60.000	0.000	×	○	0B18
P11.25	R closed relay time delay	0.000~60.000	0.005	×	○	0B19
P11.26	T closed relay time delay	0.000~60.000	0.005	×	○	0B0A
P11.27	Y2 output terminals close time delay	0.000~60.000	0.000	×	○	0B0B
P11.28	Y1 output terminals shut off time delay	0.000~60.000	0.000	×	○	0B0C
P11.29	R relay shut off time delay	0.000~60.000	0.005	×	○	0B0D
P11.30	T relay shut off time delay	0.000~60.000	0.005	×	○	0B0E
P11.31	Y2 output terminals shut off time delay	0.000~60.000	0.000	×	○	0B0F
P12 Analog input parameters						
P12.00	A11 minimum input	0.00~P12.02	0.00	×	○	0C00
P12.01	Corresponding setting of A11 minimum input	-100.0~100.0%	0.0	×	○	0C01
P12.02	A11 maximum input	P12.02~10.00	10.00	×	○	0C02
P12.03	Corresponding setting of A11 maximum input	-100.0~100.0%	100.0	×	○	0C03
P12.04	A11 filter time	0.001~9.999	0.010	×	○	0C04
P12.05	A12 minimum input	0.00~P12.07	0.00	×	○	0C05
P12.06	Corresponding setting of A12 minimum input	-100.0~100.0%	0.0	×	○	0C06
P12.07	A12 maximum	P12.05~10.00	10.00	×	○	0C07

Function code	Name of parameter	Set Range	Factory	Basic menu	change	mailing address
	input					
P12.08	Corresponding setting of AI2 maximum input	-100.0~100.0%	100.00	×	○	0C08
P12.09	AI2 filter time	0.001~9.999	0.010	×	○	0C09
P12.10	AI3 minimum input	-10.00~P12.12	0.00	×	○	0C0A
P12.11	Corresponding setting of AI3 minimum input	-100.0~100.0%	0.0	×	○	0C0B
P12.12	Corresponding setting of AI3 maximum input	P12.10~10.00	10.00	×	○	0C0C
P12.13	Corresponding setting of AI3 maximum input	-100.0~100.0%	100.00	×	○	0C0D
P12.14	AI3 filter time	0.001~9.999	0.010	×	○	0C0E
P12.15	keep					
P13 Analog output parameters						
P13.00	AO1 function selection	0: Running frequency 1: Set frequency 2: Output current(Relative double servo drive rated current) 3: Output current(Relative double the motor rated current) 4: Output voltage 5: output voltages 1 6: Output torque 7: keep 8: exciting flux 9: Output speed 10: Output power 11: Cumulative converter overloading 12: Cumulative motor overloading 13: Temperature of the servo drive 14: The temperature of the rectifier 15: PC percentage 16: PID set 17: PID Feedback 18: PID Input bias 19: PID output 20: AI1 21: AI2	0	√	○	0D00

Function code	Name of parameter	Set Range	Factory	Basic menu	change	mailing address
		22: AI3 23: After the adjustment AI1 24: After the adjustment AI2 25: After the adjustment AI3 26: DI Pulse input 27: set torque 28: Extend communication card set value 29: Simple PLC operation stage 30~31: keep				
P13.01	AO1 gain	0.0~200.0	100.0	×	○	0D01
P13.02	AO1 offset coefficient	-100.0~100.0	0.0	×	○	0D02
P13.03	AO1 Prop filter	0.001~9.999	0.010	×	○	0D03
P13.04	AO2 function selection	With AO1	0	×	○	0D04
P13.05	AO1 gain	0.0~200.0	100.0	×	○	0D05
P13.06	AO2 offset coefficient	-100.0~100.0	0.0	×	○	0D06
P13.07	AO2 Prop filter	0.001~9.999	0.010	×	○	0D07
P14 The custom input curve						
P14.00	curve adjust and choose	Unit's digit: AI1 input curve 0: Do not make adjustment curve 1: curve 1 2: curve 2 Ten's digit: AI2 input curve With AI1 set hundred's digit: AI3 input curve With AI1 set Thousand's digit: Pulse input curve With AI1 set	0x0000	√	○	0E00
P14.01	AI curve 1 minimum input	0.0~P14.03	0.0	×	○	0E01
P14.02	Corresponding setting of AI curve 1 minimum input	0.0~100.0	0.0	×	○	0E02
P14.03	AI curve 1 inflexion 1 input	P14.01~P14.05	0.0	×	○	0E03
P14.04	Corresponding setting of AI	0.0~100.0	0.0	×	○	0E04

Function code	Name of parameter	Set Range	Factory	Basic menu	change	mailing address
	curve 1 inflexion 1 input					
P14.05	AI curve 1 inflexion 2 input	P14.03~P14.07	100.0	×	○	0E05
P14.06	Corresponding setting of AI curve 1 inflexion 2 input	0.0~100.0	100.0	×	○	0E06
P14.07	AI curve 1 maximum input	P14.05~100.0	100.0	×	○	0E07
P14.08	Corresponding setting of AI curve 1 maximum input	0.0~100.0	100.0	×	○	0E08
P14.09	AI curve 2 minimum input	0.0~P14.11	0.0	×	○	0E09
P14.10	Corresponding setting of AI curve 2 minimum input	0.0~100.0	0.0	×	○	0E0A
P14.11	AI curve 2 inflexion 1 input	P14.09~P14.13	0.0	×	○	0E0B
P14.12	Corresponding setting of AI curve 2 inflexion 1 input	0.0~100.0	0.0	×	○	0E0C
P14.13	AI curve 1 inflexion 2 input	P14.11~P14.15	100.0	×	○	0E0D
P14.14	Corresponding setting of AI curve 1 inflexion 2 input	0.0~100.0	100.0	×	○	0E0E
P14.15	AI curve 1 maximum input	P14.13~100.0	100.0	×	○	0E0F
P14.16	Corresponding setting of AI curve 1 maximum input	0.0~100.0	100.0	×	○	0E10
P15 Virtual switch parameters						
P15.00	Virtual VX1 terminal function	With P10.02	0	×	×	0F00

Function code	Name of parameter	Set Range	Factory	Basic menu	change	mailing address
P15.01	Virtual terminal function VX2	With P10.02	0	×	×	0F01
P15.02	Virtual terminal function VX3	With P10.02	0	×	×	0F02
P15.03	Virtual terminal function VX4	With P10.02	0	×	×	0F03
P15.04	Virtual terminal function VX5	With P10.02	0	×	×	0F04
P15.05	Virtual terminal input source X	Virtual terminal input source selection Bit0: 0: The X1 as VX1 input 1: The virtual source as the VX1 input(P15.06) Bit1~Bit4: ditto	0x00	×	○	0F05
P15.06	Virtual terminal X virtual source selection	Virtual terminal virtual source selection Bit0: 0: VY1 as VX1 input 1: By setting P15.07 VX1 state Bit1~Bit4: ditto	0x00	×	○	0F06
P15.07	Virtual terminal X input status	Virtual terminal X input status Bit0~Bit4: VX1~VX5 0: Virtual terminal is invalid 1: Virtual terminal effective	0x00	×	○	0F07
P15.08	Virtual terminal function VY1	With P11.01	0	×	×	0F08
P15.09	Virtual terminal function VY2	With P11.01	0	×	×	0F09
P15.10	Virtual terminal function VY3	With P11.01	0	×	×	0F0A
P15.11	Virtual terminal function VY4	With P11.01	0	×	×	0F0B
P15.12	Virtual terminal function VY5	With P11.01	0	×	×	0F0C
P15.13	Virtual terminal	Virtual terminal Y effective state	0x00	×	○	0F0D

Function code	Name of parameter	Set Range	Factory	Basic menu	change	mailing address
	Y effective state	Bit0~Bit4: VY1~VY5 0: positive logic 1: negative logic				
P15.14	Closed VY1 terminal latency	0.000~60.000	0.005	×	○	0F0E
P15.15	Closed VY2 terminal latency	0.000~60.000	0.005	×	○	0F0F
P15.16	Closed VY3 terminal latency	0.000~60.000	0.005	×	○	0F10
P15.17	Closed VY4 terminal latency	0.000~60.000	0.005	×	○	0F11
P15.18	Closed VY5 terminal latency	0.000~60.000	0.005	×	○	0F12
P15.19	VY1 terminal disconnection time delay	0.000~60.000	0.005	×	○	0F13
P15.20	VY2 terminal disconnection time delay	0.000~60.000	0.005	×	○	0F14
P15.21	VY3 terminal disconnection time delay	0.000~60.000	0.005	×	○	0F15
P15.22	VY4 terminal disconnection time delay	0.000~60.000	0.005	×	○	0F16
P15.23	VY5 terminal disconnection time delay	0.000~60.000	0.005	×	○	0F17
P15.24	Virtual VA01 function	With P13.00	0	×	○	0F18
P15.25	Virtual VA02 function	With P13.00	0	×	○	0F19
P15.26	Virtual VA03 function	With P13.00	0	×	○	0F1A
P19 Servo control parameter						
P19.00	Servo running setting	Units' digit: Servo control enabled 0: Servo position control is invalid 1: Servo position control is effective	1	0	×	○
P19.01	Position given source	0: Reserve 1: High speed pulse input terminal 2: PG expansion card (Pulse given form set P51.06) 3: Multiple position given	1	0	×	×

Function code	Name of parameter	Set Range	Factory	Basic menu	change	mailing address
P19.02	Reserve	-9999~9999	1	0	×	○
P19.03	Position is given a low pass filter	0.0~6000.0	0.1ms	0.0	×	○
P19.04	Position given slip filter time coefficient 1	0.0~1000.0	0.1 ms	10.0	×	○
P19.05	Reserve					
P19.06	Electronic gear molecule 1	1~32767	1	1	×	○
P19.07	Electronic gear denominator 1	1~32767	1	1	×	○
P19.08	Electronic gear molecule 2	1~32767	1	1	×	○
P19.09	Electronic gear denominator 2	1~32767	1	1	×	○
P19.10	Rotational inertia ratio	0.50~100.00	0.01	1.00	×	×
P19.11	Reserve					
P19.12	Position loop gain 1	0.01~500.00	0.01 Hz	10.00	×	○
P19.13	Position loop gain 2	0.01~500.00	0.01 Hz	10.00	×	○
P19.14	Position ring output limit	0.0~100.0	0.1%	100.0	×	○
P19.15	Location completion conditions	0~1	1	0	×	×
P19.16	Location completion width	0~10000	1	10	×	○
P19.17	Location approach width	0~32767	1	100	×	○
P19.18	Reserve					
P19.19	Location over-error alarm selection	0~1	1	0	×	×
P19.20	Location over-error threshold level	0~32767	1	10000	×	×
P19.21	Location over-error	0~6000	1ms	10	×	×

Function code	Name of parameter	Set Range	Factory	Basic menu	change	mailing address
	checkout time					
P19.22	Servo stop mode	Under servo control, when the stop command is received: 0: After completing the current position, enter the stopped state 1: Control mode switch to speed control mode and stop again	1	0	×	×
P19.23	Speed feedforward enabled	0: Feedforward is invalid 1: Internal feedforward enabled	1	0	×	×
P19.24	Speed feedforward gain	0.00~100.00	0.01%	0.00	×	○
P19.25	Speed feedforward filtering	0.0~128.0	0.1ms	0.0	×	○
P19.26	Position loop gain switching mode	0~3	1	0	×	×
P19.27	Gain switching filter coefficient	0~65535	1	500	×	○
P19.28	Gain switching pulse error threshold	0~65535	1	50	×	○
P19.29	Gain switching speed command threshold	0.0~100.0	0.1	10.0	×	×
P20 Multistage parameters						
P20.00	Multistage frequency 1	0.00~400.00	5.00	×	○	1400
P20.01	Multistage frequency 2	0.00~400.00	10.00	×	○	1401
P20.02	Multistage frequency 3	0.00~400.00	15.00	×	○	1402
P20.03	Multistage frequency 4	0.00~400.00	20.00	×	○	1403
P20.04	Multistage frequency 5	0.00~400.00	25.00	×	○	1404
P20.05	Multistage frequency 6	0.00~400.00	30.00	×	○	1405

Function code	Name of parameter	Set Range	Factory	Basic menu	change	mailing address
P20.06	Multistage frequency 7	0.00~400.00	35.00	×	○	1406
P20.07	Multistage frequency 8	0.00~400.00	40.00	×	○	1407
P20.08	Multistage frequency 9	0.00~400.00	45.00	×	○	1408
P20.09	Multistage frequency 10	0.00~400.00	50.00	×	○	1409
P20.10	Multistage frequency 11	0.00~400.00	45.00	×	○	140A
P20.11	Multistage frequency12	0.00~400.00	40.00	×	○	140B
P20.12	Multistage frequency13	0.00~400.00	35.00	×	○	140C
P20.13	Multistage frequency14	0.00~400.00	30.00	×	○	140D
P20.14	Multistage frequency15	0.00~400.00	25.00	×	○	140E
P20.15	Multistage frequency16	0.00~400.00	20.00	×	○	140F
P20.16	Multistage closed-loop1	0.00~10.00	1.00	×	○	1410
P20.17	Multistage closed-loop2	0.00~10.00	2.00	×	○	1411
P20.18	Multistage closed-loop3	0.00~10.00	3.00	×	○	1412
P20.19	Multistage closed-loop4	0.00~10.00	4.00	×	○	1413
P20.20	Multistage closed-loop5	0.00~10.00	5.00	×	○	1414
P20.21	Multistage closed-loop6	0.00~10.00	6.00	×	○	1415
P20.22	Multistage closed-loop7	0.00~10.00	7.00	×	○	1416
P20.23	Multistage closed-loop8	0.00~10.00	8.00	×	○	1417
P20.24	Multistage closed-loop9	0.00~10.00	9.00	×	○	1418
P20.25	Multistage closed-loop10	0.00~10.00	10.00	×	○	1419
P20.26	Multistage closed-loop11	0.00~10.00	9.00	×	○	141A

Function code	Name of parameter	Set Range	Factory	Basic menu	change	mailing address
P20.27	Multistage closed-loop12	0.00~10.00	8.00	×	○	141B
P20.28	Multistage closed-loop13	0.00~10.00	7.00	×	○	141C
P20.29	Multistage closed-loop14	0.00~10.00	6.00	×	○	141D
P20.30	Multistage closed-loop15	0.00~10.00	5.00	×	○	141E
P20.31	Multistage closed-loop16	0.00~10.00	4.00	×	○	141F
P21 Simple PLC fuction						
P21.00	Simple PLC running mode	Unit's digit: LC retentive selection 0: Stop after the AC servo drive runs one cycle 1: Keep final values after the AC servo drive runs one cycle 2: Repeat after the AC servo drive runs one cycle Ten's digit :Retentive upon stop 0: No 1: Yes hundred's digit :(Retentive upon power failure) 0: No 1: Yes	0x000	√	×	1500
P21.01	Phase 1 set	Unit's digit: Deceleration time to choose 0: Deceleration time 1 1: Deceleration time 2 2: Deceleration time 3 3: Deceleration time 4 Ten's digit: Unit selection phase time 0: s 1: min hundred's digit: moving direction 0: Forward run 1: Reverse run	0x000	×	○	1501
P21.02	Phase 2 running time	0.0~6000.0	10.0	×	○	1502
P21.03	Phase 2 set	With P21.01	0x000	×	○	1503
P21.04	Phase 3 running time	0.0~6000.0	10.0	×	○	1504
P21.05	Phase 3 set	With P21.01	0x000	×	○	1505
P21.06	Phase 4 running time	0.0~6000.0	10.0	×	○	1506
P21.07	Phase 4 set	With P21.01	0x000	×	○	1507

Function code	Name of parameter	Set Range	Factory	Basic menu	change	mailing address
P21.08	Phase 5 running time	0.0~6000.0	10.0	×	○	1508
P21.09	Phase 5set	With P21.01	0x000	×	○	1509
P21.10	Phase 6 running time	0.0~6000.0	10.0	×	○	150A
P21.11	Phase 1 set	With P21.01	0x000	×	○	150B
P21.12	Phase 6 running time	0.0~6000.0	0.0	×	○	150C
P21.13	Phase 7 set	With P21.01	0x000	×	○	150D
P21.14	Phase 7 running time	0.0~6000.0	0.0	×	○	150E
P21.15	Phase 8 set	With P21.01	0x000	×	○	150F
P21.16	Phase 8 running time	0.0~6000.0	0.0	×	○	1510
P21.17	Phase 9 set	With P21.01	0x000	×	○	1511
P21.18	Phase 9 running time	0.0~6000.0	0.0	×	○	1512
P21.19	Phase 10 set	With P21.01	0x000	×	○	1513
P21.20	Phase 10 running time	0.0~6000.0	0.0	×	○	1514
P21.21	Phase 11 set	With P21.01	0x000	×	○	1515
P21.22	Phase 11 running time	0.0~6000.0	0.0	×	○	1516
P21.23	Phase 12 set	With P21.01	0x000	×	○	1517
P21.24	Phase 12 running time	0.0~6000.0	0.0	×	○	1518
P21.25	Phase 13 set	With P21.01	0x000	×	○	1519
P21.26	Phase 13 running time	0.0~6000.0	0.0	×	○	151A
P21.27	Phase 14 set	With P21.01	0x000	×	○	151B
P21.28	Phase 14 running time	0.0~6000.0	0.0	×	○	151C
P21.29	Phase 15 set	With P21.01	0x000	×	○	151D
P21.30	Phase 15 running time	0.0~6000.0	0.0	×	○	151E
P21.31	Phase 16 set	With P21.01	0x000	×	○	151F
P21.32	Phase 16 running time	0.0~6000.0	0.0	×	○	1520
P22 Closed-loop PID process parameters						
P22.00	A given channel selection	0: Digital keyboard(P22.01) 1: AI1 2: AI2	0	√	○	1600

Function code	Name of parameter	Set Range	Factory	Basic menu	change	mailing address
		3: AI3 4: Terminal pulse setting 5: More closed loop given 6: Modbus/MXLink communication 7: PLC Expand the communication card				
P22.01	Digital quantity setting	0.00~10.00	0.00	×	○	1601
P22.02	Filtering time coefficient of given channel	0.01~10.00	0.10	×	○	1602
P22.03	Feedback channel selection	0: AI1 1: AI2 2: AI3 3: AI1+AI2 4: AI1-AI2 5: (AI1,AI2)max 6: (AI1,AI2) min 7: Terminal pulse 8: Modbus/MXLink communication 9: PLC Expand the communication card	0	√	○	1603
P22.04	Filtering time coefficient of Feedback channel	0.01~10.00	0.10	×	○	1604
P22.05	PID deviation limit	0.00~20.00	0.10	×	○	1605
P22.06	Proportional gain Kp1	0.00~99.99	1.00	×	○	1606
P22.07	Integral time Ti1	0.0~600.0	1.0	×	○	1607
P22.08	Differential time Td1	0.000~9.999	0.000	×	○	1608
P22.09	Sampling cycle	0.01~60.00	0.10	×	○	1609
P22.10	PID output filter time	0.00~10.00	0.01	×	○	160A
P22.11	PID upper limit output	P21.12~100.0	100.0	×	○	160B
P22.12	PID Output lower limit	-100.0~P21.11	0.0	×	○	160C
P22.13	Closed loop control properties	units' digit: Positive and negative features 0: Forward action 1: Reverse action ten's digit: Integral regulation properties	0x00	×	×	160D

Function code	Name of parameter	Set Range	Factory	Basic menu	change	mailing address
		0: Differential regulation on deviation 1: Differential regulation on Feedback				
P22.14	Exit the detection threshold	0.0~100.0	0.0	×	×	160E
P22.15	closed-loop detection threshold	0.0~100.0	0.0	×	×	160F
P22.16	Closed-loop detection time	0.0~600.0	0.0	×	×	1610
P22.17	Feedback protections	units' digit: Low threshold protection test 0: Non detection 1: Has been testing 2: Running test, downtime is not detected ten's digit: Low threshold protection detection processing 0: Protection detection alarm, continue to run 1: To protect freedom of fault detection times, downtime hundred's digit: hign threshold protection test 0: Non detection 1: Has been testing 2: Running test, downtime is not detected Thousands' digit: High threshold protection detect processing 0: Protection detection alarm, continue to run 1:To protect freedom of fault detection times, downtime	0x0000	×	×	1611
P22.18	Feedback too high value	P22.20~100.0	95.0	×	×	1612
P22.19	Feedback widely out time	0.1~60.0	5.0	×	×	1613
P22.20	Feedback too low value	0.0~P22.18	5.0	×	×	1614
P22.21	Low feedback check out time	0.0~60.0	5.0	×	×	1615
P22.22	PID initial value	-100%~100%	0.0	×	×	1616
P22.23	PID initial value holding time	0.00~600.00	0.0	×	×	1617
P22.24	Closed loop differential limiter	-100%~100%	1.0	×	×	1618

Function code	Name of parameter	Set Range	Factory	Basic menu	change	mailing address
P22.25	Proportional gain Kp1	0.000~9.999	0.100	○	×	1619
P22.26	Integral time Ti1	0.0~600.0	1.0	○	×	161A
P22.27	Differential time Td1	0.000~9.999	0.000	○	×	161B
P22.28	PID parameter switchover condition	0: No switchover 1: Switchover via DI 2: Automatic switchover based on deviation	0	○	×	161C
P22.29	PID switch low bias	0.0~P22.30	20.0	○	×	161D
P22.30	PID switch high bias	P22.29~100.0	80.0	○	×	161E
P23 Swing frequency fuction						
P23.00	Swing frequency	0: ban 1: enabled	0	√	○	1700
P23.01	Swing control	0: Relative to the central frequency 1: Relative to the maximum frequency	0	×	○	1701
P23.02	Swing frequency amplitude	0.00~50.00	10.00	×	○	1702
P23.03	Jump frequency amplitude	0.00~50.00	10.00	×	○	1703
P23.04	Swing frequency cycle	0.1~1000.0	20.0	×	○	1704
P23.05	Triangular wave rising time coefficient	0.0~100.0	50.0	×	○	1705
P23.06	keep					1706
P23.07	Keep					1707
P30 Status surveillance						
P30.00	output frequency	0.00~400.00	0.00	×	*	1E00
P30.01	output frequency (Including slip compensation)	0.00~400.00	0.00	×	*	1E01
P30.02	set frequency	0.00~400.00	0.00	×	*	1E02
P30.03	current output	0.0~3*Ib	0.0	×	*	1E03
P30.04	Output Voltage	0~P50.17	0	×	*	1E04
P30.05	busbar voltage	0~1000	0	×	*	1E05
P30.06	output torque	-300.0~300.0	0.0	×	*	1E06
P30.07	output power	-200.0~200.0	0.0	×	*	1E07

Function code	Name of parameter	Set Range	Factory	Basic menu	change	mailing address
P30.08	motor running speed	0~60000	0	×	*	1E08
P30.09	Motor line speed	0.00~600.00	0.00	×	*	1E09
P30.10	motor power factor	-1.00~1.00	0.00	×	*	1E0A
P30.11	SWITCH STATUS	0x000~0xFFF	0x000	√	*	1E0B
P30.12	DI Input Frequency	0.00~80.00	0.00	×	*	1E0C
P30.13	DI Enter the percentage	-100.0~100.0	0.0	×	*	1E0D
P30.14	AI1 Input	0.00~10.00	0.00	√	*	1E0E
P30.15	AI2 Input	0.00~10.00	0.00	×	*	1E0F
P30.16	AI3 Input	-10.00~10.00	0.00	×	*	1E10
P30.17	AI1 Input percentage	-100.0~100.0	0.0	√	*	1E11
P30.18	AI2 Input percentage	-100.0~100.0	0.0	×	*	1E12
P30.19	AI3 Input percentage	-100.0~100.0	0.0	×	*	1E13
P30.20	1 operation of converter	0x0000~0xFFFF	0x0000	×	*	1E14
P30.21	2 operation of converter	0x0000~0xFFFF	0x0000	×	*	1E15
P30.22	Servo drive alarm status	0~15	0	×	*	1E16
P30.23	AO1 output	0.00~10.00	0.00	×	*	1E17
P30.24	AO2 output	0.00~10.00	0.00	×	*	1E18
P30.25	VAO1 output	0.00~10.00	0.00	×	*	1E19
P30.26	VAO2 output	0.00~10.00	0.00	×	*	1E1A
P30.27	VAO3 output	0.00~10.00	0.00	×	*	1E1B
P30.28	Terminal count	0~65535	0	×	*	1E1C
P30.29	encoder pulse number	0~65535	0	×	*	1E1D
P31 Application of monitoring						
P31.00	PID Control state	0x0000~0xFFFF	0x0000	×	*	1F00
P31.01	PID setting	0.0~100.0	0.0	√	*	1F01
P31.02	PID Feedback	0.0~100.0	0.0	√	*	1F02
P31.03	PID Deviation	-100.0~100.0	0.0	×	*	1F03
P31.04	PID output	-100.0~100.0	0.0	√	*	1F04
P31.05	Modbus/MXLin	0~65535	0	×	*	1F05

Function code	Name of parameter	Set Range	Factory	Basic menu	change	mailing address
	k Frame reception counter					
P31.06	Modbus/MXLin k Effective frame reception counter	0~65535	0	×	*	1F06
P31.07	auxiliary frequency	0.00~400.0	0.00	×	*	1F07
P31.08	Simple PLC operation stage	1~16	1	×	*	1F08
P31.09	Terminal number 485 CRC error detection	0~65535	0	×	*	1F09
P31.10	Expansion card number 485 CRC error detection	0~65535	0	×	*	1F0A
P31.11	Communication card 1	0~9	0	×	*	1F0B
P31.12	Communication card 2	0~9	0	×	*	1F0C
P31.13	Communication card frame reception counter	0~65535	0	×	*	1F0D
P31.14 ~ P31.19	Keep					
P32 Maintain surveillance						
P32.00	Motor overload accumulative total value	0.0~100.0	0.0	×	*	2000
P32.01	Servo drive overload accumulative total value	0.0~100.0	0.0	×	*	2001
P32.02	motor power consumption low	0~10000	0	×	*	2002
P32.03	motor power	0~65535	0	×	*	2003

Function code	Name of parameter	Set Range	Factory	Basic menu	change	mailing address
	consumption high					
P32.04	Temperature side of rectifier module	0.0~100.0	0.0	×	*	2004
P32.05	Servo drive side temperature	0.0~100.0	0.0	√	*	2005
P32.06	conduction time	0~65535	0	×	*	2006
P32.07	running time	0~65535	0	×	*	2007
P32.08	fan running time	0~65535	0	×	*	2008
P32.09	Regularly run time remaining	0.00~650.00	0.00	×	*	2009
P32.10	current fault code	0~99	0	×	*	200A
P32.11	current alarm code	0~99	0	×	*	200B
P34 failure record						
P34.00	1st fault type	000~099	000	√	*	2200
P34.01	Bus voltage upon 1rd fault	000~1000	000	×	*	2201
P34.02	Current upon 1rd fault	0.0~999.9	0.0	×	*	2202
P34.03	voltage upon 1rd fault	0~380	0	×	*	2203
P34.04	Frequency upon 1rd fault	0.00~400.00	0.00	×	*	2204
P34.05	Output terminal status upon 1rd fault	0x0000~0xFFFF	0x0000	×	*	2205
P34.06	AC servo drive status upon 1rd fault	0x0000~0xFFFF	0x0000	×	*	2206
P34.07	2st fault type	000~099	000	√	*	2207
P34.08	Bus voltage upon 2rd fault	0~1000	0	×	*	2208
P34.09	Current upon 2rd fault	0.0~999.9	0.0	×	*	2209
P34.10	voltage upon 2rd fault	0~380	0	×	*	220A

Function code	Name of parameter	Set Range	Factory	Basic menu	change	mailing address
P34.11	Frequency upon 2rd fault	0.00~400.00	0.00	×	*	220B
P34.12	Output terminal status upon 2rd fault	0x0000~0xFFFF	0x0000	×	*	220C
P34.13	AC servo drive status upon 2rd fault	0x0000~0xFFFF	0x0000	×	*	220D
P34.14	3st fault type	000~099	000	√	*	220E
P34.15	Bus voltage upon 3rd fault	000~1000	0	×	*	220F
P34.16	Current upon 3rd fault	0.0~999.9	0.0	×	*	2210
P34.17	voltage upon 3rd fault	0~380	0	×	*	2211
P34.18	Frequency upon 3rd fault	0.00~400.00	0.00	×	*	2212
P34.19	Output terminal status upon 2rd fault	0x0000~0x0FFF	0x0000	×	*	2213
P34.20	AC servo drive status upon 3rd fault	0x0000~0x0FFF	0x0000	×	*	2214
P50 System configuration management						
P50.00	user password	00000~65535	00000	√	○	3200
P50.01	list view	0: Basic menu mode 1: Advanced menu mode 2: user menu mode 3: factory value comparison mode	0	√	○	3201
P50.02	Parameters to protect	0: Besides the function code all the parameters from modification 1: Besides the function code and P00.00, modification is prohibited 2: All parameters are allowed to change	0	√	×	3202
P50.03	keyboard Settings	units' digit: MK key function to choose 0: non-function 1: Keyboard inching function 2: Free parking(All commands channel) 3:Take the running direction(keyboard command channel, stopping memory) 4:Take the running direction(keyboard command channel, stopping no memory)	0x0001	×	×	3203

Function code	Name of parameter	Set Range	Factory	Basic menu	change	mailing address
		5: Menu to switch function(Power lost is not saved) 6: command switch function(Effective downtime) (After pressing the MK need to press the ENTER key for 3 seconds to take effect) 7:command switch function(Transit stop are effective) ten's digit: STOP Double-click the function 0: non-function 1: Free parking(All commands channel) units' digit: STOP in key functions 0: keyboard control method is invalid 1: keyboard control mode in down way down 2: keyboard control way free downtime ten's digit: Key lock function 0: latch up free 1: lock 2:except RUN、STOP Key lock all 3:except SHIFT Key lock all 4: except MK Key lock all				
P50.04	MK function keys switching sequence	units' digit: Switch command order 0: Keyboard ↔ terminal 1: Keyboard ↔ communication 2: Terminal ↔ communication 3: Keyboard ↔ terminal ↔ communications 4: Keyboar↔communicat ion communication terminal ↔ extension ten's digit: Menu switching sequence 0: user menu mode ↔ senior menu mode 1: user menu mode ↔ value comparison model factory 2: user menu mode ↔ basic menu 3: Basic menu mode ↔ senior menu mode ↔ user mode 4: Basic menu mode ↔ senior menu ↔ user menu mode ↔ factory value comparison mode	0x00	×	×	3204
P50.05	Braking energy function	0: forbid 1: Enable	0	×	×	3205
P50.06	Braking action voltage	three phase: 650~750 single phase: 370~400	720 380	×	○	3206
P50.07	Braking energy usage	0.0~100.0	10.0	×	○	3207
P50.08	Fan operation	0: Electricity has been running	1	×	○	3208

Function code	Name of parameter	Set Range	Factory	Basic menu	change	mailing address
	control	1: Servo drive operation is running 2: According to the machine temperature automatic control				
P50.09	Stop display preferences	Binary set: 0- Not Displayed 1- display units' digit: Bit0: set frequency(Hz) Bit1: Set the torque(%) Bit2: busbar voltage Bit3: terminal state ten's digit: Bit0: AI1(V) Bit1: AI2(V) Bit2: AI3(V) Bit3: Pulse input frequency hundred's digit: Bit0: Close Loop Correction (%) Bit1: closed loop setting Bit2: Terminal count Bit3: PLC run phase thousands' digit: keep	0x0005	×	○	3209
P50.10	According to parameter selection 1	Binary set: 0- Not Displayed 1- display units' digit: Bit0: output frequency(Hz) Bit1: set frequency(Hz) Bit2: output current(A) Bit3: output voltage(V) ten's digit: Bit0: busbar voltage(V) Bit1: output power(%) Bit2: Output torque(%) Bit3: Output Power Factor (%) hundred's digit: Bit0: torque given(%) Bit1: AI1(V) Bit2: AI2(V) Bit3: AI3(V) thousands' digit: Bit0:AI1(%)Internal percentile, the curve adjustments Bit1:AI2(%)Internal percentile, the curve adjustments	0x0017	×	○	320A

Function code	Name of parameter	Set Range	Factory	Basic menu	change	mailing address
		Bit2:AI3(%)Internal percentile, the curve adjustments Bit3: keep				
P50.11	According to parameter selection 2	Binary set: 0- Not Displayed 1- display units' digit: Bit0: Terminal state Bit1: Terminal count Bit2: Pulse input frequency Bit3: PLC operation/running period of location ten's digit: Bit0: Close Loop Correction (%) Bit1: closed loop setting(%) Bit2: closed loop error(%) Bit3: closed-loop output(%) hundred's digit: Bit0:Cumulative frequency converter overloading(%) Bit1: Motor overload the cumulative(%) Bit2: Temperature of the servo drive Bit3: temperature of the rectifier Thousands' digit: Bit0: Running RPM Bit1: Line speed Bit2: position error Bit3: keep	0x0000	×	○	320B
P50.12	Product code	0~999	100	×	*	320C
P50.13	Control panel software version number	1.00~9.99	Factory set	×	*	320D
P50.14	Keyboard version of the software version	1.00~9.99	Factory set	×	*	320E
P50.15	Servo drive load type	0: constant torque load 1: Variable torque load	0	×	×	320F
P50.16	Servo drive power rating	0.0~999.9	Factory set	×	*	3210
P50.17	Servo drive rated voltage	0~1000	Factory set	×	*	3211
P50.18	Servo drive rated current	0.0~1000.0	25.0	×	*	3212
P50.19	Parameters of the copy	11: Block parameters uploaded to the operation panel EEPROM	00	×	×	3213

Function code	Name of parameter	Set Range	Factory	Basic menu	change	mailing address
		22:Download from the block operation panel EEPROM parameters 33:Download from the block operation panel EEPROM parameters (except motor parameters)				
P50.20	Parameters to restore the backup Settings	0: failure to actuate 1~10: keep 11: Restore basic menu parameters 12~21: keep 22: Restore advanced menu parameters 23: keep 24: Restore advanced menu parameters (excluding motor) 25: keep 26: Restore factory value mapping parameters 27~32: keep 33: Restore the user custom menu parameters 34~43: keep 44: Eliminate malfunction records 45~54: keep 55: Parameters of the backup 56~65: keep 66: recover from a backup area parameters 67~99: keep	00	√	×	3214
P51 Encoders config						
P51.00	Encoder 1 per pulse number	1~10000	1000	×	×	3300
P51.01	encoder 1 direction	0: Forward 1: reverse	0	×	×	3301
P51.02	encoder 1 signal filter coefficients	0~9	0	×	○	3302
P51.03	Z pulse fall insensible ones	0.0~10.0	2.0	×	×	3303
P51.04	Z pulse fall insensible ones	0~100	0	×	×	3304
P51.05	encoder output frequency division 1	1~255	1	×	×	3305
P51.06	encoder configuration	0x0000~0xFFFF	0x0000	×	×	3306
P51.07	Encoder 2 per pulse number	1~10000	1000	×	×	3307

Function code	Name of parameter	Set Range	Factory	Basic menu	change	mailing address
P51.08	encoder 2 direction	0: Forward 1: reverse	0	×	×	3308
P51.09	encoder 2 signal filter coefficients	0~9	0	×	○	3309
P51.10	Z pulse fall insensible ones	0.0~10.0	2.0	×	×	330A
P51.11	Z pulse fall insensible ones	0~100	0	×	×	330B
P51.12	encoder output frequency division 2	1~255	1	×	×	330C
P51.13	encoder configuration	0x0000~0xFFFF	0x0000	×	×	330D
P52 communications parameters						
P52.00	Communication configuration	units' digit: Baud rate choice 0: 4800BPS 1: 9600BPS 2: 19200BPS 3: 38400BPS 4: 57600BPS 5: 115200BPS ten's digit: Data Format 0: 1-8-2-N, RTU 1: 1-8-1-E, RTU 2: 1-8-1-O, RTU hundred's digit: communication protocol 0: Modbus 1: MXLink	0x01	√	×	3400
P52.01	machine address	0~247	5	×	×	3401
P52.02	Communication timeout detection time	0.0~60.0	0.0	×	×	3402
P52.03	The machine response delay	0.000~1.000	0.005	×	×	3403
P52.04	Frequency ratio	0.00~99.99	1.00	×	○	3404
P52.05	Communication parameters protection option	units' digit: Communication control parameters (0 x3bxx) user password protection Settings 0: Communication access 0 x3bxx parameter is not protected by the user password 1: Communication access 0 x3bxx parameters are	0x0011	×	○	3405

Function code	Name of parameter	Set Range	Factory	Basic menu	change	mailing address
		protected by user password ten's digit: P57 communication save the parameters (0x39xx) user password protection Settings 0:Communication access P57 parameters, speaking, reading and writing is not protected by the user password 1:Communication access P57 parameters write protected by the user password, read from the password protection 2:Communication access P57 parameters, speaking, reading and writing are protected by the user password hundred's digit: P57 group Settings hidden communication save the parameters 0: Display 1: Hidden Thousand's digit: Address mapping parameter hidden P58 group Settings 0: Display 1: Hidden				
P52.06	Communication parameters save option	units' digit : Write command to save option 0: 0x06, 0x10, 0x12, 0x17 1: 0x06 Power-down save, 0x10, 0x12, 0x17 Power-down no save 2: 0x06,0x10,0x12,0x17 save the command when power supply drop ten's place: user to save parameters P57 save option 0: Be bound by communication write command is saved 1: Don't be bound by communication write command to save, write command to save hundred, thousand: reservations	0x00	×	○	3406
P52.07	Keep					3407
P52.08	Expansion CARDS coefficient of a given frequency	0.00~99.99	1.00	×	*	3408
P52.09	Expansion CARDS communication options	0x00~0x10	0x00	×	*	3409
P52.10	Commonly used state parameter index	0~41	11	×	*	340A
P52.11	Commonly used for a given	0~23	1	×	*	340B

Function code	Name of parameter	Set Range	Factory	Basic menu	change	mailing address
	parameter index					
P53 Users to customize parameter						
P53.00~P53.31	User-defined function code	0.00~89.99	0.00~53.32	×	○	3500~351F
P53.32	Users to customize parameter is invalid	When a user customization parameters, function code is 5332, then the users to customize parameter is invalid	0	×	*	3520
P57.00	Saving parameters 1	0~65535	0	×	○	3900
P57.01	Saving parameters 2	0~65535	0	×	○	3901
P57.02	Saving parameters 3	0~65535	0	×	○	3902
P57.03	Saving parameters 4	0~65535	0	×	○	3903
P57.04	Saving parameters 5	0~65535	0	×	○	3904
P57.05	Saving parameters 6	0~65535	0	×	○	3905
P57.06	Saving parameters 7	0~65535	0	×	○	3906
P57.07	Saving parameters 8	0~65535	0	×	○	3907
P57.08	Saving parameters 9	0~65535	0	×	○	3908
P57.09	Saving parameters 10	0~65535	0	×	○	3909
P57.10	Saving parameters 11	0~65535	0	×	○	390A
P57.11	Saving parameters 12	0~65535	0	×	○	390B
P57.12	Saving parameters 13	0~65535	0	×	○	390C
P57.13	Saving parameters 14	0~65535	0	×	○	390D
P57.14	Saving parameters 15	0~65535	0	×	○	390E
P57.15	Saving parameters 16	0~65535	0	×	○	390F
P57.16	Saving parameters 17	0~65535	0	×	○	3910

Function code	Name of parameter	Set Range	Factory	Basic menu	change	mailing address
P57.17	Saving parameters 18	0~65535	0	×	○	3911
P57.18	Saving parameters 19	0~65535	0	×	○	3912
P57.19	Saving parameters 20	0~65535	0	×	○	3913
P57.20	Saving parameters 21	0~65535	0	×	○	3914
P57.21	Saving parameters 22	0~65535	0	×	○	3915
P57.22	Saving parameters 23	0~65535	0	×	○	3916
P57.23	Saving parameters 24	0~65535	0	×	○	3917
P57.24	Saving parameters 25	0~65535	0	×	○	3918
P57.25	Saving parameters 26	0~65535	0	×	○	3919
P57.26	Saving parameters 27	0~65535	0	×	○	391A
P57.27	Saving parameters 28	0~65535	0	×	○	391B
P57.28	Saving parameters 29	0~65535	0	×	○	391C
P57.29	Saving parameters 30	0~65535	0	×	○	391D
P57.30	Saving parameters 31	0~65535	0	×	○	391E
P57.31	Saving parameters 32	0~65535	0	×	○	391F
P57.32	Saving parameters 33	0~65535	0	×	○	3920
P57.33	Saving parameters 34	0~65535	0	×	○	3921
P57.34	Saving parameters 35	0~65535	0	×	○	3922
P57.35	Saving parameters 36	0~65535	0	×	○	3923
P57.36	Saving parameters 37	0~65535	0	×	○	3924
P57.37	Saving parameters 38	0~65535	0	×	○	3925

Function code	Name of parameter	Set Range	Factory	Basic menu	change	mailing address
P57.38	Saving parameters 39	0~65535	0	×	○	3926
P57.39	Saving parameters 40	0~65535	0	×	○	3927
P57.40	Saving parameters 41	0~65535	0	×	○	3928
P57.41	Saving parameters 42	0~65535	0	×	○	3929
P57.42	Saving parameters 43	0~65535	0	×	○	392A
P57.43	Saving parameters 44	0~65535	0	×	○	392B
P57.44	Saving parameters 45	0~65535	0	×	○	392C
P57.45	Saving parameters 46	0~65535	0	×	○	392D
P57.46	Saving parameters 47	0~65535	0	×	○	392E
P57.47	Saving parameters 48	0~65535	0	×	○	392F
P57.48	Saving parameters 49	0~65535	0	×	○	3930
P57.49	Saving parameters 50	0~65535	0	×	○	3931
P57.50	Saving parameters 51	0~65535	0	×	○	3932
P57.51	Saving parameters 52	0~65535	0	×	○	3933
P57.52	Saving parameters 53	0~65535	0	×	○	3934
P57.53	Saving parameters 54	0~65535	0	×	○	3935
P57.54	Saving parameters 55	0~65535	0	×	○	3936
P57.55	Saving parameters 56	0~65535	0	×	○	3937
P57.56	Saving parameters 57	0~65535	0	×	○	3938
P57.57	Saving parameters 58	0~65535	0	×	○	3939
P57.58	Saving parameters 59	0~65535	0	×	○	393A

Function code	Name of parameter	Set Range	Factory	Basic menu	change	mailing address
P57.59	Saving parameters 60	0~65535	0	×	○	393B
P57.60	Saving parameters 61	0~65535	0	×	○	393C
P57.61	Saving parameters 62	0~65535	0	×	○	393D
P57.62	Saving parameters 63	0~65535	0	×	○	393E
P57.63	Saving parameters 64	0~65535	0	×	○	393F
P58 communications parameters						
P58.00	Address mapping make	Address mapping make 0: forbide 1:enable	0	×	×	3A00
P58.01	Mapping address1	0x0000~0xFFFF	0x0000	×	×	3A01
P58.02	Argument Addresses1	0x0000~0xFFFF	0x0000	×	×	3A02
P58.03	Mapping address2	0x0000~0xFFFF	0x0000	×	×	3A03
P58.04	Argument Addresses2	0x0000~0xFFFF	0x0000	×	×	3A04
P58.05	Mapping address3	0x0000~0xFFFF	0x0000	×	×	3A05
P58.06	Argument Addresses3	0x0000~0xFFFF	0x0000	×	×	3A06
P58.07	Mapping address4	0x0000~0xFFFF	0x0000	×	×	3A07
P58.08	Argument Addresses4	0x0000~0xFFFF	0x0000	×	×	3A08
P58.09	Mapping address5	0x0000~0xFFFF	0x0000	×	×	3A09
P58.10	Argument Addresses5	0x0000~0xFFFF	0x0000	×	×	3A0A
P58.11	Mapping address6	0x0000~0xFFFF	0x0000	×	×	3A0B
P58.12	Argument Addresses6	0x0000~0xFFFF	0x0000	×	×	3A0C
P58.13	Mapping address7	0x0000~0xFFFF	0x0000	×	×	3A0D
P58.14	Argument Addresses7	0x0000~0xFFFF	0x0000	×	×	3A0E
P58.15	Mapping	0x0000~0xFFFF	0x0000	×	×	3A0F

Function code	Name of parameter	Set Range	Factory	Basic menu	change	mailing address
	address8					
P58.16	Argument Addresses8	0x0000~0xFFFF	0x0000	×	×	3A10
P58.17	Mapping address9	0x0000~0xFFFF	0x0000	×	×	3A11
P58.18	Argument Addresses9	0x0000~0xFFFF	0x0000	×	×	3A12
P58.19	Mapping address10	0x0000~0xFFFF	0x0000	×	×	3A13
P58.20	Argument Addresses10	0x0000~0xFFFF	0x0000	×	×	3A14
P58.21	Mapping address11	0x0000~0xFFFF	0x0000	×	×	3A15
P58.22	Argument Addresses11	0x0000~0xFFFF	0x0000	×	×	3A16
P58.23	Mapping address12	0x0000~0xFFFF	0x0000	×	×	3A17
P58.24	Argument Addresses12	0x0000~0xFFFF	0x0000	×	×	3A18
P58.25	Mapping address13	0x0000~0xFFFF	0x0000	×	×	3A19
P58.26	Argument Addresses13	0x0000~0xFFFF	0x0000	×	×	3A1A
P58.27	Mapping address14	0x0000~0xFFFF	0x0000	×	×	3A1B
P58.28	Argument Addresses14	0x0000~0xFFFF	0x0000	×	×	3A1C
P58.29	Mapping address15	0x0000~0xFFFF	0x0000	×	×	3A1D
P58.30	Argument Addresses15	0x0000~0xFFFF	0x0000	×	×	3A1E
P58.31	Mapping address 16	0x0000~0xFFFF	0x0000	×	×	3A1F
P58.32	Argument Addresses 16	0x0000~0xFFFF	0x0000	×	×	3A20
P58.33	Mapping address17	0x0000~0xFFFF	0x0000	×	×	3A21
P58.34	Argument Addresses17	0x0000~0xFFFF	0x0000	×	×	3A22
P58.35	Mapping address18	0x0000~0xFFFF	0x0000	×	×	3A23
P58.36	Argument	0x0000~0xFFFF	0x0000	×	×	3A24

Function code	Name of parameter	Set Range	Factory	Basic menu	change	mailing address
	Addresses18					
P58.37	Mapping address19	0x0000~0xFFFF	0x0000	×	×	3A25
P58.38	Argument Addresses19	0x0000~0xFFFF	0x0000	×	×	3A26
P58.39	Mapping address20	0x0000~0xFFFF	0x0000	×	×	3A27
P58.40	Argument Addresses20	0x0000~0xFFFF	0x0000	×	×	3A28
P58.41	Mapping address21	0x0000~0xFFFF	0x0000	×	×	3A29
P58.42	Argument Addresses21	0x0000~0xFFFF	0x0000	×	×	3A2A
P58.43	Mapping address22	0x0000~0xFFFF	0x0000	×	×	3A2B
P58.44	Argument Addresses22	0x0000~0xFFFF	0x0000	×	×	3A2C
P58.45	Mapping address23	0x0000~0xFFFF	0x0000	×	×	3A2D
P58.46	Argument Addresses23	0x0000~0xFFFF	0x0000	×	×	3A2E
P58.47	Mapping address24	0x0000~0xFFFF	0x0000	×	×	3A2F
P58.48	Argument Addresses24	0x0000~0xFFFF	0x0000	×	×	3A30
P58.49	Mapping address25	0x0000~0xFFFF	0x0000	×	×	3A31
P58.50	Argument Addresses25	0x0000~0xFFFF	0x0000	×	×	3A32
P58.51	Mapping address26	0x0000~0xFFFF	0x0000	×	×	3A33
P58.52	Argument Addresses26	0x0000~0xFFFF	0x0000	×	×	3A34
P58.53	Mapping address27	0x0000~0xFFFF	0x0000	×	×	3A35
P58.54	Argument Addresses27	0x0000~0xFFFF	0x0000	×	×	3A36
P58.55	Mapping address28	0x0000~0xFFFF	0x0000	×	×	3A37
P58.56	Argument Addresses28	0x0000~0xFFFF	0x0000	×	×	3A38
P58.57	Mapping	0x0000~0xFFFF	0x0000	×	×	3A39

Function code	Name of parameter	Set Range	Factory	Basic menu	change	mailing address
	address29					
P58.58	Argument Addresses29	0x0000~0xFFFF	0x0000	×	×	3A3A
P58.59	Mapping address30	0x0000~0xFFFF	0x0000	×	×	3A3B
P58.60	Argument Addresses30	0x0000~0xFFFF	0x0000	×	×	3A3C
P58.61	Mapping address31	0x0000~0xFFFF	0x0000	×	×	3A3D
P58.62	Argument Addresses31	0x0000~0xFFFF	0x0000	×	×	3A3E
P58.63	Mapping address32	0x0000~0xFFFF	0x0000	×	×	3A3F
P58.64	Argument Addresses32	0x0000~0xFFFF	0x0000	×	×	3A40
P58.65	Reflection Parameter 1	0x0000~0xFFFF	0xFFFF	×	×	3A41
P58.66	Reflection parameter2	0x0000~0xFFFF	0xFFFF	×	×	3A42
P58.67	Reflection parameter3	0x0000~0xFFFF	0xFFFF	×	×	3A43
P58.68	Reflection parameter4	0x0000~0xFFFF	0xFFFF	×	×	3A44
P58.69	Reflection parameter5	0x0000~0xFFFF	0xFFFF	×	×	3A45
P58.70	Reflection parameter6	0x0000~0xFFFF	0xFFFF	×	×	3A46
P58.71	Reflection parameter7	0x0000~0xFFFF	0xFFFF	×	×	3A47
P58.72	Reflection parameter8	0x0000~0xFFFF	0xFFFF	×	×	3A48
P58.73	Reflection parameter9	0x0000~0xFFFF	0xFFFF	×	×	3A49
P58.74	Reflection parameter10	0x0000~0xFFFF	0xFFFF	×	×	3A4A
P58.75	Reflection parameter11	0x0000~0xFFFF	0xFFFF	×	×	3A4B
P58.76	Reflection parameter12	0x0000~0xFFFF	0xFFFF	×	×	3A4C
P58.77	Reflection parameter13	0x0000~0xFFFF	0xFFFF	×	×	3A4D
P58.78	Reflection	0x0000~0xFFFF	0xFFFF	×	×	3A4E













Function code	Name of parameter	Set Range	Factory	Basic menu	change	mailing address
	parameter14					
P58.79	Reflection parameter15	0x0000~0xFFFF	0xFFFF	×	×	3A4F
P58.80	Reflection parameter16	0x0000~0xFFFF	0xFFFF	×	×	3A50
P58.81	Reflection parameter17	0x0000~0xFFFF	0xFFFF	×	×	3A51
P58.82	Reflection parameter18	0x0000~0xFFFF	0xFFFF	×	×	3A52
P58.83	Reflection parameter19	0x0000~0xFFFF	0xFFFF	×	×	3A53
P58.84	Reflection parameter20	0x0000~0xFFFF	0xFFFF	×	×	3A54
P60/P61 Electric machine parameter						
P60.00	Rated motor power	0.4~999.9	machine type determin e	√	×	3C00
P60.01	Rated motor current	0.1~999.9		×	×	3C01
P60.02	Rated motor voltage	60~380		×	×	3C02
P60.03	Rated motor frequency	1.00~400.00		×	×	3C03
P60.04	Rated motor rotational speed	1~30000		×	×	3C04
P60.05	Power factor	0.01~1.00		×	×	3C05
P60.06	no-load current	0.1~999.9	8.4	×	×	3C06
P60.07	Stator resistance (asynchronous motor)	0.01~50.00	3.22	×	×	3C07
P60.08	Rotor resistance (asynchronous motor)	0.01~50.00	2.54	×	×	3C08
P60.09	Leakage inductive reactance (asynchronous motor)	0.01~50.00	20.73	×	×	3C09
P60.10	Mutual inductive reactance	0.1~2000.0	243.6	×	×	3C0A





Function code	Name of parameter	Set Range	Factory	Basic menu	change	mailing address
	(asynchronous motor)					
P60.11	Parameter Auto-tune	0~2	0	×	×	3C0B
P60.12	Motor overload protection mode selection	0~2	1	×	×	3C0C
P60.13	Motor overload protection curve coefficient	10.0~120.0	100.0	×	×	3C0D
P60.14	Synchronous motor pole logarithm	1~50	1	4	×	×
P60.15	Synchronous motor stator resistance	0.01~50.00	0.01%	3.22	×	×
P60.16	Synchronous motor D axis inductance	0.1~2000.0	0.1	2.5	×	×
P60.17	Synchronous motor Q axis inductance	0.1~2000.0	0.1	20.7	×	×
P60.18	Synchronous motor counter electromotive force	0.1~6553.5	0.1	243.6	×	×
P60.19	Synchronous motor parameters self-learning	0~2	1	0	×	×
P60.20	Learn to pull in current	0.0~80.0	0.1	20.0	×	×
P60.21	UVW encoder phase sequence	0~1	1	0	×	×
P60.22	UVW encoder offset angle	0.00~360.00	0.01	0.00	×	×
P60.23	Z pulse offset Angle	0.00~360.00	0.01	0.00	×	×
P60.24	Counter EMF calculating coefficient type	0~9	1	1	×	×
P60.25	Counter EMF	0~65535	1	48.0	×	×

Function code	Name of parameter	Set Range	Factory	Basic menu	change	mailing address
	calculating coefficient					
P60.26	Reserve					
P60.27	Reserve					
P60.28	PM motor excitation current 1	0.0~100.0	0.1	20.0	×	×
P60.29	PM motor excitation frequency point 1	0.0~100.0	0.1	10.0	×	×
P60.30	PM motor excitation current 2	0.0~100.0	0.1	10.0	×	×
P60.31	PM motor excitation frequency point 2	0.0~100.0	0.1	40.0	×	×
P60.32	Reserve					
P60.33	Reserve					
P60.34	Weak magnetic curve coefficient	0.0~400.0	0.1	100.0	×	×
P60.35	Maximum weak magnetic current	0.0~300.0	0.1	50.0	×	×
P60.36	Reserve					
P60.37	Weak magnetic ring gain	0.000~65.535	0.001	1.000	×	×
P60.38	The maximum output voltage of the motor	0.0~200.0	0.1	110.0	×	×
P60.39	Start pull in current	0.0~150.0	0.1	50.0	×	×
P60.40	Start pull in current duration	0.0~600.0	1.0	1.0	×	×
P60.41	Start pull in current upper frequency limit	0.00~100.00	0.01	5.00	×	×

Chapter 7 Common symbols display and fault alarm processing methods

7.1 Common display symbols causes and treatment



Display	Name	Possible Causes	Solutions
	Running is prohibited	<ol style="list-style-type: none"> 1. Terminal effective state, the terminal choose 13 - running is prohibited 2. Communications given the run command is prohibited 	<ol style="list-style-type: none"> 1. Run ban function terminal status as invalid 2. Communications given allowed to run command
	Run for	Frequency is less than the given start frequency at startup	<ol style="list-style-type: none"> 1. Check frequency size, so that it is greater than or equal to start frequency 2. P01.01 start frequency changes to 0.0
	Motor parameters tuning	In the operation of the motor self-tuning	Motor self-tuning complete disappear automatically
	Run to suspend	<ol style="list-style-type: none"> 1. Terminal chose 47 - external interrupt input function, and terminal state is effective 2. In the Nick of time for automatic reset 	<ol style="list-style-type: none"> 1. The external interrupt input function terminal state as invalid 2. The time interval to disappear automatically
	Dc brake	Starting dc brake or stop dc brake	Brake complete disappear automatically
	Speed tracking	Starting speed tracking process	Speed tracking complete disappear automatically
	Operation panel	Use the MK keys to switch command channel	Switch to complete or cancel will disappear automatically
	terminal		
	485 communication		
	Communication expansion card		
	Key lock effective	Through the key combination on the keyboard lock, During the operation or key lock button operation	Using a combination of keys to unlock
	Key lock is invalid	Through the key combinations of keys to unlock operation	
	Basic menu	Use the MK keys on the keyboard menu to switch	After the completion of the switch will automatically disappear







	Top menu		
	The user menu		
	The default option is		
	The user password authentication	User password protection is valid input user password correctly	
	The user password authentication failed	User password protection is valid user password input error	Input the correct password









7.2 Fault alarm and processing method











There are two kinds of MV series servo drive fault type: Fault and alarm. When failure occurs and alarm, Frequency converter according to the customer set us the corresponding code. When the servo drive quoted fault code, servo drive blockade output, And failure indicator ALM normally on. It is only to press the reset signal, servo drive can normal boot, When p code converter report, normal operation of converter, failure indicator ALM flicker. When the servo drive to the fault code, the alarm light is normally on.

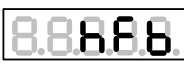







The following table lists the common fault causes and solutions, so that customers in accordance with this section suggest checking, analysis the cause of the problem, find out the solution. If the problem cannot be solved, can contact the purchased servo drive agents or directly with your company.









The fault		The alarm		The fault types	Possible reasons for failure type	The solution
NO.	code	NO.	code			
01	 Er.01			To accelerate the flow	1. The motor speed too fast 2. The motor speed is too fast 3. Load mutation or abnormal 4. Interphase short circuit or three-phase output To ground short circuit 5. Starting rotation of the motor 6. A manual torque increase is too large 7. V/F curve is not appropriate 8. Motor vector control system parameters	1. Increase the acceleration time 2. Increase the acceleration/acceleration/deceleration time 3. Check the load 4. Check the output connection, measuring machine And resistance, the insulation 5. Use dc braking or starting Speed tracking starting rotation of the motor 6. Set the appropriate manual torque
02				Slow flow		









The fault		The alarm		The fault types	Possible reasons for failure type	The solution
NO.	code	NO.	code			
	Er.02				are set Setting is not correct	Mention of appreciation
03				Constant speed over current	9. The closed-loop vector PG feedback often 10. The grid voltage is too low 11. The servo drive power is too small	7. Set the appropriate V/F of the curve 8. Properly set parameters of motor nameplates Learning and motor parameters 9. Check the PG card connection 10. Check the input power supply 11. Increase the frequency converter capacity
	Er.03					
04				Accelerate the overvoltage	1. The abnormal input power 2. The instantaneous power, motor to stop Stop rotating to start again	1. Check the input power supply 2. To ensure that the motor after stop running restart
	Er.04					
05				Acceleration/acceleration/deceleration overvoltage	1. Abnormal input power 2. Slow down too fast 3. the load inertia	1. Check the input power 2. Increasing the acceleration/acceleration/deceleration time 3. With proper braking resistor
	Er.05					
06				Constant speed over voltage	1. The power input voltage instability 2. The load inertia	1. Check the input power, the use of pay Input flow reactor 2. Use the appropriate braking resistor
	Er.06					
07				The servo drive overload	1. Power grid voltage is too low 2. Speed is too fast 3. servo drive power is too small/motor is too	1. Check the input power supply 2. Increase the acceleration time 3. Select adapter







The fault		The alarm		The fault types	Possible reasons for failure type	The solution
NO.	code	NO.	code			
	Er.07		AL.09		large 4. Moments after the blackout, motor to stop rotating and start again	converter or motor 4.Ensure the stop and start the motor
08				Motor overload	1. Power grid voltage is too low 2. The motor rated current setting is not correct 3. Motor blocked or load sudden increase	1. Check the input power supply 2. Set the motor rated current 3. Check the load and torque increase quantity adjustment 4.Increase the coefficient of motor overload protection value
	Er.08		AL.09			
09				servo drive is overheating	1. The fan is damaged or duct obstruction 2. The environment temperature is too high 3. The carrier frequency set too high 4. Temperature detecting element damage	1. Replace the fan or clean up the air duct 2. Reduce the environmental temperature 3. Use or lower carrier 4. Contact service or the company
	Er.09					
10				Rectifier is overheating	1. Motor phase fault 2. The abnormal load change	1. Check the motor wiring 2. Check the load
	Er.10					
11				The module failure	1. The input power supply R, S and T phase 2. Input power serious imbalance	1. Check the input wiring 2.Check the input power supply
	Er.11					
12		01		The input phase	1. There are a lack of output U, V, W 2. The driver board	1. Check the wiring installation 2. Contact service or our company
	Er.12		AL.01			
13		02		The output phase		
	Er.13		AL.02			







The fault		The alarm		The fault types	Possible reasons for failure type	The solution
NO.	code	NO.	code			
14				External fault	1.Through the terminal input the external fault signal effectively	1. External reset after fault clearance The fault
	Er. 14					
15		06		Process of the closed loop feedback is too low	1. The feedback is broken 2. Low feedback detection parameter Settings	1. The testing feedback line is disconnected 2. Reset the feedback loss protection parameters
	Er. 15		AL.06			
16		07		Process of the closed loop feedback is too high	1. The process of the closed loop disconnect the given line 2. The simulation to the timing, given value is too small	1. The detection of closed loop whether a given line break 2. Check whether simulation given within the range
	Er. 16		AL.07			
17		11		DEV speed deviation is too large	1. ASR parameter setting is not reasonable 2. Excessive speed deviation detection threshold is too small 3. Load volatile	1. Reset P02 set of parameters 2. Too much increase speed deviation detection threshold 3. To eliminate the load fluctuation
	Er. 17		AL. 11			
18		12		OS overspeeding	1. The encoder wire break 2. The encoder parameter setting is not correct 3.Rapid detection threshold is too small	1.Check the encoder connection 2.Reset the encoder parameters 3.Increase rapid detection threshold
	Er. 18		Er. 12			
19				Tuning the fault	1. The motor parameters according to the nameplate not set 2. The timeout parameter identification process	1. According to the nameplate set motor parameters correctly 2. Check the servo drive to motor fuses
	Er. 19					
20		08		underload	1.Abnormal load 2.Motor parameter	1.Check the load 2.Reset the motor

The fault		The alarm		The fault types	Possible reasons for failure type	The solution
NO.	code	NO.	code			
	Er.20		AL.08		setting is not correct 3.Off load detection level is too big	parameters 3.Reduced load detection levels
22				Contact or and failure	1. The power grid voltage is too low 2. The relay is damaged 3. The electrical damage of buffer resistance 4. The control circuit damage 5. Input phase	1. Check the input power supply 2. Contact service or our company 3. Contact service or the company 4. Contact service or the company 5. Check the input power and wiring again
	Er.22					
23		13		More than or less torque ¹	1. The motor parameters according to the nameplate not set 2. The torque detection threshold setting is not appropriate	1. According to the nameplate set motor parameters correctly 2. Reset the torque detection threshold
	Er.23		AL.13			
24		14		More than or less torque ¹	1. The motor parameters according to the nameplate not set 2. The torque detection threshold setting is not appropriate	1. According to the b nameplate set motor parameters correctly 2. Reset the torque detection threshold
	Er.24		AL.14			
25				To ground short circuit	1. The motor power line and ground short answer 2. The motor and circuit aging, insulation deterioration	1. Check the motor wiring to ensure power line and ground wire insulation 2. Replace the motor
	Er.25					
26		05		Brake pipe failure	1. The brake line fault 2. Braking resistor is too small 3. Brake pipe damage	1. Check the rewiring 2. Replace the high power brake pipe 3. Replace the brake pipe or contact service or our company
	Er.26		AL.05			

The fault		The alarm		The fault types	Possible reasons for failure type	The solution
NO.	code	NO.	code			
27				The ADC reference a given fault	<ol style="list-style-type: none"> 1. A given hardware circuit malfunction 2. Software failure 	<ol style="list-style-type: none"> 1. Contact service or the company 2. Contact service or our company
	Er.27					
28				Current sampling circuit malfunction	<ol style="list-style-type: none"> 1. Control panel loose connection or plug-in 2. Auxiliary power supply damage 3. Damage of the signal processing circuit 	<ol style="list-style-type: none"> 1. Check and reinstall the terminal 2. Contact service or the company 3. Contact service or the company
	Er.28					
29				CPU interference failure	<ol style="list-style-type: none"> 1. The external interference is serious 2. The CPU to read and write error 	<ol style="list-style-type: none"> 1. Press the STOP/RESET button RESET or plus the power filter in power input side 2. Press the STOP/RESET button RESET or contact the service provider or the company
	Er.29					
30		04		485 communication failures	<ol style="list-style-type: none"> 1. A serial port communication parameter setting is not correct 2. 485 line break line terminal 3. Baud rate setting is not correct 	<ol style="list-style-type: none"> 1. To set the correct parameters of serial communication 2. Check 485 line connection 3. Set the correct baud rate
	Er.30		AL.04			
32		03		EEPROM failure	<ol style="list-style-type: none"> 1. The control parameters of the error, speaking, reading and writing Block 2. The EEPROM is damaged 	<ol style="list-style-type: none"> 1. Press the STOP/RESET button RESET Contact service or the company 2. Contact service or our company
	Er.32		AL.03			
33				Copy and fault	<ol style="list-style-type: none"> 1. Block operation panel EEPROM problems 2. The servo drive 	<ol style="list-style-type: none"> 1. Contact service or the company 2. Check the operation

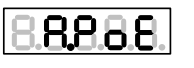
The fault		The alarm		The fault types	Possible reasons for failure type	The solution
NO.	code	NO.	code			
	Er.33				parameters to the operation panel data errors 3.Operation panel version number is not correct	panel connections 3.Contact service or the company
36				Keyboard communication failures	The operation panel communication break line	Check the operation panel with the host of the telecommunication lines
	Er.36					
37				Software supercurrent	1. Acceleration/acceleration/deceleration time is too short 2. The current detection circuit fault 3. Start the rotation of the motor	1.Extend the acceleration/acceleration/deceleration time 2.Contact service or the company 3.Motor stationary before you start
	Er.37					
38				The module failure	1. The reference module failure	1. The reference module failure
	Er.38					
39				Programming errors		
	Er.39					
40		10		The fault current limiting continued	1. Motor acceleration/acceleration/deceleration too fast 2. The power grid voltage is too low 3. The servo drive power is too small 4. Load inertia torque too large	1. Increasing the acceleration/acceleration/deceleration time 2. Check the input power or power grid voltage 3. Replace the high power servo drive
	Er.40		AL.10			
41				Under voltage	1. The power grid voltage is too low	1. Check the input power or power grid voltage
	Er.41					
42				U phase module	1. Motor phase fault 2. The servo drive	1. Check the motor wiring

The fault		The alarm		The fault types	Possible reasons for failure type	The solution
NO.	code	NO.	code			
	Er.42			to protect	output to ground short circuit	2. Check the motor insulation
43				V phase module to protect	3. The acceleration/acceleration/deceleration time Settings are too short	3. Prolonged acceleration/acceleration/deceleration
	Er.43					
44				phase module to protect	4. Abnormal load change 5. Interfere with serious	4. Check the load 5. Contact the manufacturer
	Er.44					
45				servo drive modules detect abnormal temperature	1. The temperature detecting element connection disconnect 2. Temperature detection is beyond range	1. Check the temperature detecting element connection 2. Ensure that use the environment temperature within the prescribed scope
	Er.45					
46				Rectifier module detect abnormal temperature	3. The temperature detecting element damage	3. Change the temperature detecting element
	Er.46					
47				Motor encoder single-line breakdown	1. The motor feedback encoder break line 2. The encoder communication head poor contact	1. Check the encoder wiring 2. Check coding communication connector
	Er.47					
48				Set the encoder single-line breakdown	1. The encoder feedback pulse is lost 2. Encoder communication connector poor contact	1. Check the encoder wiring 2. Check the encoder communications connector
	Er.48					
49				Set the encoder single-line	1. The encoder feedback pulse is lost 2. Encoder	1. Check the encoder wiring 2. Check the encoder

The fault		The alarm		The fault types	Possible reasons for failure type	The solution
NO.	code	NO.	code			
	Er.49			communication breakdown	connector poor contact	communications connector
51	 Er.51			Electronic gear ratio set transfinite fault	Electronic gear ratio is not in the range of 0.001 ~ 1000.000	Electronic gear ratio is set correctly
52	 Er.52	19	 AL.19	The position error overrun	1、 Pulse given oversize 2、 Acceleration and deceleration too fast 3、 The position pulse error is large 4、 P00.11 maximum frequency and P00.13 frequency upper limit	1、 Reduces the pulse given frequency 2、 Increase the Acceleration and deceleration time 3、 Amplification P00.11 P00.13 frequency values
53	 Er.53			Position given overflow	Pulse frequency given beyond the technical scope	1、 Reduces the pulse given frequency 2、 Reduction of gear ratio
57	 Er.57			Powered time out fault	Timed run time arrive	1、 Enter the password, set the timing time right 2、 Enter the password correctly and set it to no password
58	 Er.58	20	 AL.20	Motor locked-rotor	The motor load is too large, drive protection	1、 Reduce the load size 2、 Increase the level of the drive or motor

Pay attention to

- ◆ Please carefully chosen fault alarm function, otherwise may cause accident expanded, personal injury and property damage to property.

7.3 Common fault alarm and processing methods

No.	Common phenomenon	Possible reasons for	The solution
1	There is no display at power-on	1. There is no power supply to the servo drive or the power input to the servo drive is too low.	1. Check the power supply. 2. Check the bus voltage. 3. Check the control board and servo drive

No.	Common phenomenon	Possible reasons for	The solution
		2.The power supply of the switch on the servo drive board of the servo drive is faulty. 3.The reatifier bridge is damaged. 4.The cable connecting the control board and the servo drive board and the operation panel breaks. 5.The control board is damaged.	board, keyboard ribbon cable 4 . Contact the manufacturer
2	The motor does not rotate after the servo drive runs	1.The motor and the motor cables. 2.The servo drive parameters are set improperly (motor parameters). 3.The cable between the servo drive board and the control board is in poor contact. 4.The servo drive board is faulty.	1.Ensure the cable between the servo drive and the motor is normal. 2. Reset the servo drive parameter 3. Test control board and servo drive board wiring 4. Contact the manufacturer
3	The motor running abnormal vibration or noise	1. The given unstable frequency 2. Vector control, the speed loop parameter setting is not appropriate 3. Closed-loop vector control, PG feedback parameter setting is not correct or PG feedback interference 4. Vector control, motor parameter setting is not correct	1. Inspection frequency for a given channel, set appropriate filter is given 2. From small to large set appropriate speed loop parameters 3. Check the encoder parameters or to earth shield encoder circuit interference 4. Check the motor parameters, the parameters self-learning or manually set the motor parameters
4	The servo drive frequent over-voltage or over-current	1. servo drive input and output wiring anomaly 2. Acceleration/acceleration/deceleration parameter setting problem 3. The load fluctuation big 4. The servo drive power is too small	1. The servo drive input and output wiring 2. Reset the acceleration/deceleration parameters 3. Reduce the load of volatility 4. Replace the high level power servo drive
5	Frequent current limit on the frequency converter	1.Motor acceleration/deceleration time too fast 2. Power grid voltage is too low 3. servo drive power is too small 4. The load inertia torque too large	1. Increase the acceleration/deceleration time 2. Check the input power or power grid voltage 3. Replace the high level power servo drive
6	The servo drive to frequent overload	1. Power grid voltage is too low 2. Speed is too fast 3. The servo drive power is too small or motor is too big 4. Moments after the blackout, restart in the motor rotation	1. Check the input power 2. Increase the acceleration time 3. Choose adapter servo drive or motor 4. To ensure that the motor stop running after the restart
7	The servo drive to	1. Large carrier frequency	1. Reduce the carrier frequency

No.	Common phenomenon	Possible reasons for	The solution
	frequent overheating	2. Stalling a fan or air duct plug 3. Thermistor damage 4. Working environment temperature is too high	2. Replace the fan or fan foreign body 3. Contact the manufacturer 4. Work environment is higher than 40 °C, please reduce the rated power use
8	Switch terminal failure	1. The servo drive parameter error 2. No + 24 v power supply 3. The control board failure 4. The external fault	1. Reset the servo drive parameter 2. Check terminal + 24 v power supply 3. Contact the manufacturer
9	DO no high-speed pulse output	1. The servo drive parameter error 2. No + 24 v power supply 3. Great resistance 4. The panel fault	1. Reset the servo drive parameter 2. Check the terminal for + 24 v power supply 3. Pull up resistors access 4. Contact the manufacturer
10	Abnormal communication	1.The jamming signal big or wrong wiring 2.Communication parameter setting is not correct 3.Control panel fault	1.Communication line and the circular (shielded wire) and grounded 2. Review the communication parameters 3. Contact the manufacturer
11	Closed-loop vector control, the motor speed is far less than the target	1.Encoder failure or a connection error 2.Motor parameter setting is not correct 3.Closed-loop vector control, PG feedback parameter setting is not correct or PG feedback interference	1. Check the encoder and wiring 2. Check the motor parameters, the parameters self-learning or manually set the motor parameters 3. Check the encoder parameters for earthing interference shielding encoder circuit

Chapter 8 Maintenance and maintenance

 warning	<ul style="list-style-type: none"> ◆ Maintenance should be professional. ◆ Before maintenance, must cut off the servo drive power supply, maintenance work after power light extinguished. ◆ Maintenance personnel must according to the maintenance of the specified method. ◆ Maintenance personnel need to wear electrostatic ring as far as possible don't direct contact to touch on the PCB components, easy damage of static frequency converter device. ◆ After the completion of the maintenance, all to tighten the screws.
--	--

The servo drive will be bad parts inside, even if the normal use ,if more than life ,will slao be failure.

So in order to prevent the servo drive failure, Ensure the normal order of the VDF, prolong the service life of servo drive, need for frequency converter regular maintenance.

8.1 Daily maintenance

Check the project	Check the content
The input power	Confirm whether the input voltage/frequency within the scope of the permit
The motor	Check for abnormal vibration motor, fever, and presence of abnormal noise and the problem of lack of phase line
Panel displays	Panel display is normal
fan	Fan operation is normal, without sundry jam, and so on and so forth
The Servo Drive	Check whether there is any abnormal fever on servo drive, the presence of abnormal vibration
The surrounding environment	Surrounding environment conform to the requirements of the specification, confirm there is no oil mist, dust and water coagulation in the frequency converter, etc

8.2 Regular inspection

The company regularly check table of servo drive as shown below. In general, to once every 3 to 6 months it is advisable to regularly check,but please combined with the actual operation of the machine and working environment, To determine the reasonable inspection frequency. Periodic inspection helps prevent damage of function of variation and the product.

In order to prevent electric shock, Please do not in the state of power on terminal operations.Otherwise there will be a risk of electric shock.

Check before, please cut off all the power of the equipment. Even if cut off the power supply, internal and residual voltage in the capacitor, for main circuit dc voltage drop below 36v, After the lights of charge indicator of servo drive go out to check operation After the lights go out to check operation.

Regular inspection table

Check the project	check the content	Fault corresponding strategies	Inspectors	Inspection qualified
The primary loop				

Check the project	check the content	Fault corresponding strategies	Inspectors	Inspection qualified
Overall check	Using the megohmmeter check (main circuit terminal and earthing terminal)	Contact service or the company		
	If there's any discoloration due to overheating or aging components, all parts are in damage or deformation	Contact service or the company		
	Too much dust, oil mist, etc	With dry compressed air to clean (esd)		
The wire	Whether the power cord, motor discoloration, damage and aging due to overheating; Whether line skin breakage, cracks, discoloration, etc	Replace damaged wires		
amphenol connector	Terminals for wear, damage, loose, etc	Tighten the screws or replace terminals		
Braking resistor	Whether discoloration caused by overheating of the insulator	Slight fading is normal; Faded badly, please ensure that the connection is bad or choose more powerful resistance		
Electrolytic capacitor	Whether the capacitance discharge, swelling, discoloration, cracks, etc	Repair or replace damaged parts, serious when replacing the entire frequency converter		
Diode, IGBT, rectifier bridge	Whether is stained with trash and dust, whether because of fever and poor contact	Professional welding or replacement		
Control circuit				
The whole	Whether is stained with too much dust, oil mist, etc	With dry compressed air to clean (esd)		
	If there's any discoloration due to overheating or aging components, all parts are in deformation and damage	Repair or replace damaged parts, serious when replacing the entire frequency converter		
The control panel	Whether Showing is correct、 Whether the panel dirt	With dry compressed air to clean up; When there is a bad situation Showing smudgy or operation key, please contact with the company		

Check the project	check the content	Fault corresponding strategies	Inspectors	Inspection qualified
terminal	Terminals for wear, loose, damage, etc	Tighten the screws or replace terminals		
The wire	Whether line color, damage and aging; Whether line skin breakage, cracks, discoloration, etc	Replace damaged wires		
The cooling system				
fan	Whether there is abnormal sound and vibration of the motor Whether there is any damage or loss of blades	With dry compressed air to clean or replace the cooling fan		
Heat sinks	If stained with trash and dust and dirt	With dry compressed air to remove rubbish and dust		
vent	Inlet, outlet blockage or stained with foreign body	With dry compressed air to remove obstacles and dust		

MIKOM Electrical Technology Co.,Ltd.

Add:No.85,Dandong Road,Hi-tech Zone,Weihai,Shangdong Province

E-mail:support@mikom.com.cn

Http://www.mikom.com.cn

Technical Support :400-680-8951



All rights reserved.
The contents are subject to
change without prior notice.