

MIKOM

MF Series V/F Inverter User Manual

V1.2



MIKOM Electrical Technology Co.,Ltd.

Preface

Thank you for purchasing the MF10 series multi-function type V/F converter developed by Weihai MIKOM Electrical Technology Co., Ltd.

This manual describes the correct use of the MF series inverter, including selection, parameter setting, commissioning, maintenance & inspection. Read and understand the manual before use and forward the manual to the end user.

Inverter is precision electronic products, for first-time users of this product, should read this manual carefully. When you happen any problems in use and can't help you with the solution of this manual, please relate our local agent or directly contact with our company, our professional and technical personnel will be positive to serve you.

Product Checking:

Upon unpacking, check:

- Whether the nameplate model and AC drive ratings are consistent with your order. The box contains the AC drive, certificate of conformity, user manual and warranty card.
 - Whether the AC drive is damaged during transportation. If you find any omission or damage, contact Inovance or your supplier immediately.
-

Catalogue

Chapter 1	Safety Information	1
1.1	Safety Information	1
1.2	Inverter scrap matters needing attention	3
Chapter 2	Product Specifications	3
2.1	Model Code	3
2.1.1	Explanation to nameplate	3
2.1.2	Series Description	3
2.2	Technical Specifications	3
2.3	Inverter model and adaptation motor	5
2.4	Inverter parts name	6
Chapter 3	Wiring Installation	7
3.1	Inverter overall dimensions	7
3.2	Installation of interval and distance	9
3.3	Description of Main Circuit wiring and Terminals	9
3.3.1	Description of MF10 single/three phase inverter terminals	9
3.3.2	Description of MF20 single/three phase inverter terminals	10
3.3.3	The inverter system main circuit terminal wiring and grounding	10
3.4	The inverter control circuit wiring and terminals	12
3.4.1	Description of MF10 series inverter control circuit terminal	12
3.4.2	Description of MF20 series inverter control circuit terminal	15
3.4.3	The related instructions of control circuit	16
3.4.4	Communication wiring	17
3.5	The MF series inverter system configuration scheme	18
Chapter 4	The operation of the keyboard	20
4.1	Operation panel is introduced	20
4.1.1	Panel display shows	20
4.1.2	Keyboard button description	21
4.2	Function parameter setting method	22
4.2.1	Description of inverter function block	22
4.2.2	Inverter password Settings	24
4.2.3	Lock and unlock operation panel	24
4.3	The inverter to electricity	24
Chapter 5	Function parameter profiles	102

5.1	Function parameter profiles.....	102
Chapter 6	Common symbols display and fault alarm processing methods.....	101
6.2	Fault alarm and processing method	101
6.3	Common fault alarm and processing methods.....	107
Chapter 7	Maintenance and maintenance	105
7.1	Daily maintenance.....	105
7.2	Regular inspection.....	105

Chapter 1 Safety Information

1.1 Safety Information

In this manual, the notices are graded based on the degree of danger:















indicates that failure to comply with the notice will result in severe personal injury or even death.



indicates that failure to comply with the notice will result in personal injury or property damage.

Read this manual carefully so that you have a thorough understanding. Installation, commissioning or maintenance may be performed in conjunction with this chapter. Inovance will assume no liability or responsibility for any injury or loss caused by improper operation.

Use	Safety Grade	Precautions
Before installation	 Danger	<ul style="list-style-type: none"> ◆ Do not install the equipment if you find water seepage, component missing or damage upon unpacking. ◆ Do not install the equipment if the packing list does not conform to the product you received.
	 Warning	<ul style="list-style-type: none"> ◆ Handle the equipment with care during transportation to prevent damage to the equipment. ◆ Do not use the equipment if any component is damaged or missing. Failure to comply will result in personal injury. ◆ Do not touch the components with your hands. Failure to comply will result in static electricity damage.
During installation	 Danger	<ul style="list-style-type: none"> ◆ Install the equipment on incombustible objects such as metal, and keep it away from combustible materials. Failure to comply may result in a fire. ◆ Do not loosen the fixed screws of the components, especially the screws with red mark.
	 Warning	<ul style="list-style-type: none"> ◆ Do not drop wire end or screw into the AC drive. Failure to comply will result in damage to the AC drive. ◆ Install the AC drive in places free of vibration and direct sunlight. ◆ When two AC drives are laid in the same cabinet, arrange the installation positions properly to ensure the cooling effect.
At wiring	 Danger	<ul style="list-style-type: none"> ◆ Wiring must be performed only by qualified personnel under instructions described in this manual. Failure to comply may result in unexpected accidents. ◆ A circuit breaker must be used to isolate the power supply and the AC drive. Failure to comply may result in a fire. ◆ Ensure that the power supply is cut off before wiring. Failure to comply may result in electric shock.

Use	Safety Grade	Precautions
		<ul style="list-style-type: none"> ◆ Tie the AC drive to ground properly by standard. Failure to comply may result in electric shock.
		<ul style="list-style-type: none"> ◆ Never connect the power cables to the output terminals (U,V, W) of the AC drive. Pay attention to the marks of the wiring terminals and ensure correct wiring. Failure to comply will result in damage to the AC drive. ◆ Never connect the braking resistor between the DC bus terminals (+) and (-). Failure to comply may result in a fire. ◆ Use wire sizes recommended in the manual. Failure to comply may result in accidents. ◆ Use a shielded cable for the encoder, and ensure that the shielding layer is reliably grounded.
Before power-on		<ul style="list-style-type: none"> ◆ Check that the following requirements are met: <ul style="list-style-type: none"> – The voltage class of the power supply is consistent with the rated voltage class of the AC drive. – The input terminals (R, S, T) and output terminals (U, V, W) are properly connected. – No short-circuit exists in the peripheral circuit. – The wiring is secured. Failure to comply will result in damage to the AC drive ◆ Do not perform the voltage resistance test on any part of the AC drive because such test has been done in the factory. Failure to comply will result in accidents.
		<ul style="list-style-type: none"> ◆ Cover the AC drive properly before power-on to prevent electric shock. ◆ All peripheral devices must be connected properly under the instructions described in this manual. Failure to comply will result in accidents.
After power-on		<ul style="list-style-type: none"> ◆ Do not open the AC drive's cover after power-on. Failure to comply may result in electric shock. ◆ Do not touch any I/O terminal of the AC drive. Failure to comply may result in electric shock.
		<ul style="list-style-type: none"> ◆ Do not touch the rotating part of the motor during the motor auto-tuning or running. Failure to comply will result in accidents. ◆ Do not change the default settings of the AC drive. Failure to comply will result in damage to the AC drive.
During operation		<ul style="list-style-type: none"> ◆ Do not touch the fan or the discharging resistor to check the temperature. Failure to comply will result in personal burnt. ◆ Signal detection must be performed only by qualified personnel during operation. Failure to comply will result in personal injury or damage to the AC drive.
		<ul style="list-style-type: none"> ◆ Avoid objects falling into the AC drive when it is running. Failure to comply will

Use	Safety Grade	Precautions
		<p>result in damage to the AC drive.</p> <ul style="list-style-type: none"> ◆ Do not start/stop the AC drive by turning the contactor ON/OFF. Failure to comply will result in damage to the AC drive.
<p>During maintenance</p>		<ul style="list-style-type: none"> ◆ Repair or maintenance of the AC drive may be performed only by qualified personnel. Failure to comply will result in personal injury or damage to the AC drive. ◆ Do not repair or maintain the AC drive at power-on. Failure to comply will result in electric shock. ◆ Repair or maintain the AC drive only ten minutes after the AC drive is powered off. This allows for the residual voltage in the capacitor to discharge to a safe value. Failure to comply will result in personal injury. ◆ Ensure that the AC drive is disconnected from all power supplies before starting repair or maintenance on the AC drive. ◆ Set and check the parameters again after the AC drive is replaced. ◆ All the pluggable components must be plugged or removed only after power-off. ◆ The rotating motor generally feeds back power to the AC drive. As a result, the AC drive is still charged even if the motor stops, and the power supply is cut off. Thus ensure that the AC drive is disconnected from the motor before starting repair or maintenance on the AC drive.

1.2 Inverter scrap matters needing attention

<p>Please note:</p>
<ul style="list-style-type: none"> ◆ The electrolytic capacitors on the main circuits and PCB may explode when they are burnt. ◆ Poisonous gas is generated when the plastic parts are burnt. ◆ Treat them as ordinary industrial waste.

Chapter 2 Product Specifications

2.1 Model Code

2.1.1 Explanation to nameplate

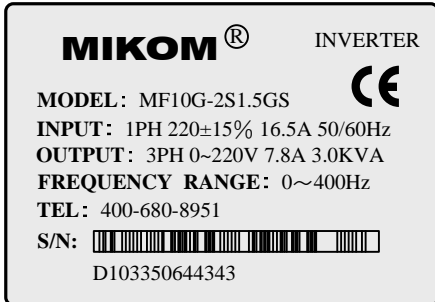

2-1 Nameplate

2.1.2 Series Description

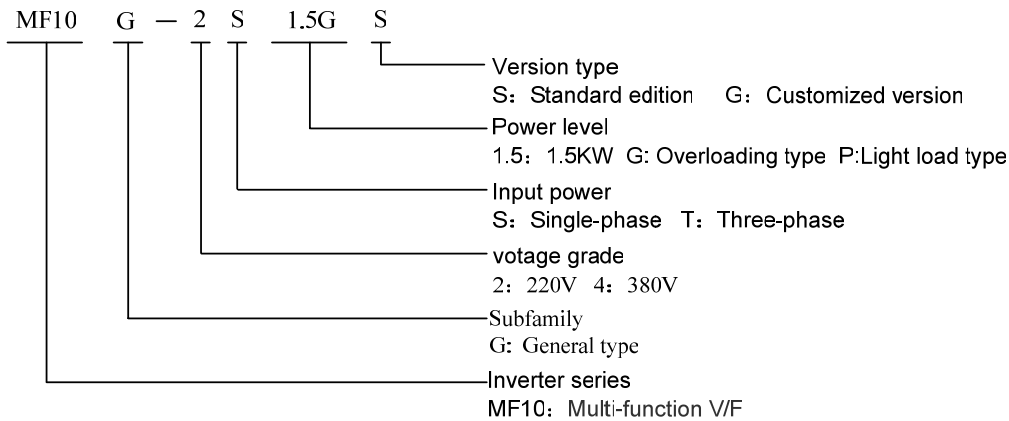

2-2 Inverter series

2.2 Technical Specifications

Chart 2-1 Technology index

Item		Specifications
Input	Rated voltage, frequency	single-phase:220V±15%,50Hz/60Hz,frequency:±5% three-phase:380V±15%,50Hz/60Hz,frequency:±5%
	Rated current	Refer to the rating (Chart 2-2)
Output	Voltage	0~input voltage
	Frequency	0~400Hz
	Current overload capacity	150% Rated current for 1min,180% Rated current for 10s, 200% Rated current for 1s
	Modulation Mode	V/F modulate
	Motor type	General motors, frequency conversion motor
	Speed range	V/F 1:50
	Startup torque	V/F 1Hz 100% rated torque

Item		Specifications
Standard functions	Speed stability accuracy	V/F 0.5% rated speed
	Velocity pulsation	V/F 0.5% rated speed
	Frequency accuracy	Digital setting: Max frequency $\times\pm 0.02\%$; Analog setting: Max frequency $\times\pm 1\%$
	Torque boost	Automatic torque increase; Manual torque increase 0.1%~30.0% rated torque
	V/F curve	Three ways: Straight-line ;users set V/F curve, Power down torque characteristic curve
	Ramp mode	Two kinds of way: Straight-line ramp、S-curve ramp Four groups of acceleration/deceleration time with the range of 0.1~3600s
	DC braking	DC braking frequency:0.00~60.00Hz Braking time: 0.1~30.0s
	Jog	Jog frequency range:0.10~60.00Hz; Jog acceleration/deceleration time:0.1~60.0s, Jog time interval can be set
	Multistage speed operation	Through the built-in PLC control or terminal control 8 segment speed operation
	Built-in PID	It realizes process-controlled closed loop control system easily.
	Automatic energy saving operation	Automatic optimization control according to the load situation, achieve energy-saving operation
	Auto voltage regulation(AVR)	It can keep constant output voltage automatically when the mains voltage changes.
	Automatic current limiting	Current limit automatically during the operation, prevent frequent over-current fault tripping
	Textile pendulum frequency	Textile pendulum frequency control, the realization of center frequency adjustable frequency function
	Fixed-length control	Through the terminal count input function, the realization of fixed length control
	Busbar voltage over-voltage suppression	Real-time dynamic control of busbar voltage, prevent the frequent overvoltage fault tripping
Power dip ride through	The load feedback energy compensates the voltage reduction so that the AC drive can continue to run for a short time.	
Run control	Bind function	Bind the run command channel and the frequency of a given channel, synchronous switch
	Run the command channel	Operation panel control command channel、terminal control command channel、Modbus communication command channel. Can switch through a variety of ways.
	Given frequency channel	Digital given,Analog voltage,Analog current setting, simple PLC setting, Multistage speed setting, process of the closed loop setting、Modbus/MXLink communications setting. Can switch through a variety of ways.

Item		Specifications
	protect function	Input/output phase loss protection, overcurrent protection, overvoltage protection, undervoltage protection, overheat protection and overload protection.
	Auxiliary frequency source	It can implement fine tuning of auxiliary frequency and frequency synthesis.
Peripheral interface	Analog input	2roads analog signal input 1 road 0~10V/4~20mA, 1 road panel potentiometer -10~+10V
	Analog output	1 roads analog signal output 0~10V, Can realize the set frequency, output frequency and so on the analog output.
	Digital input	5-way multi-function input terminals
	Digital output	1 way multifunctional output terminals
	relay output	1 road relay output:ROA NC, ROB NO, ROC COM
Communication	485 communication	Standard 485 difference signal, support the Modbus protocol and MXLink protocol(Support Modbus address mapping)
panel	LED display	It can display a set frequency, output frequency, output voltage, output current and other parameters
	Key lock to choose	By setting the buttons can change some or all of the lock, in order to prevent wrong operation
Other	Installation location	Indoor, free from direct sunlight, dust, corrosive gas, combustible gas, oil smoke, vapour, drip or salt.
	Ambient temperature	-10℃~50℃,de-rated if the ambient temperature is more than 40℃
	Altitude	Lower than 1000 m
	Humidity	5%~95%RH, without condensing
	Vibration	Less than 5.9m/s ² (0.6g)
	Storage temperature	-40℃~+70℃

2.3 Inverter model and adaptation motor

Chart 2-2 Inverter adaptation motor list

Number	Model	Input voltage(V)	Rated capacity (KVA)	Rated power current(A)	Rated output current(A)	Adaptation motor(KW)
1	MF10G-2S0.4GS	single-phase 220±15%	1.0	4.5	3.1	0.4
2	MF10G-2S0.75GS		1.5	9.3	4.7	0.75
3	MF10G-2S1.5GS		3.0	16.5	7.8	1.5
4	MF10G-4T0.75GS	three-phase 380±15%	1.5	3.4	2.5	0.75
5	MF10G-4T1.5GS		2.5	5.0	3.7	1.5
6	MF10G-4T2.2GS		3.0	5.8	5.0	2.2

7	MF20G-2S0.4GS	single-phase 220 ± 15%	1.0	4.5	3.1	0.4
8	MF20G-2S0.75GS		1.5	9.3	4.7	0.75
9	MF20G-2S1.5GS		3.0	16.5	7.8	1.5
10	MF20G-2S2.2GS		4.0	23	10	2.2
11	MF20G-4T0.75GS	three-phase 380 ± 15%	1.5	3.4	2.5	0.75
12	MF20G-4T1.5GS		2.5	5.0	3.7	1.5
13	MF20G-4T2.2GS		3.0	5.8	5.0	2.2
14	MF20G-4T4GS		5.9	10.5	9.3	3.7
15	MF20G-4T5.5GS		8.6	16.5	14.0	5.5
16	MF20G-4T7.5GS		11.2	20.5	17.0	7.5
17	MF20G-4T11GS		17.0	26.0	25.0	11

2.4 Inverter parts name

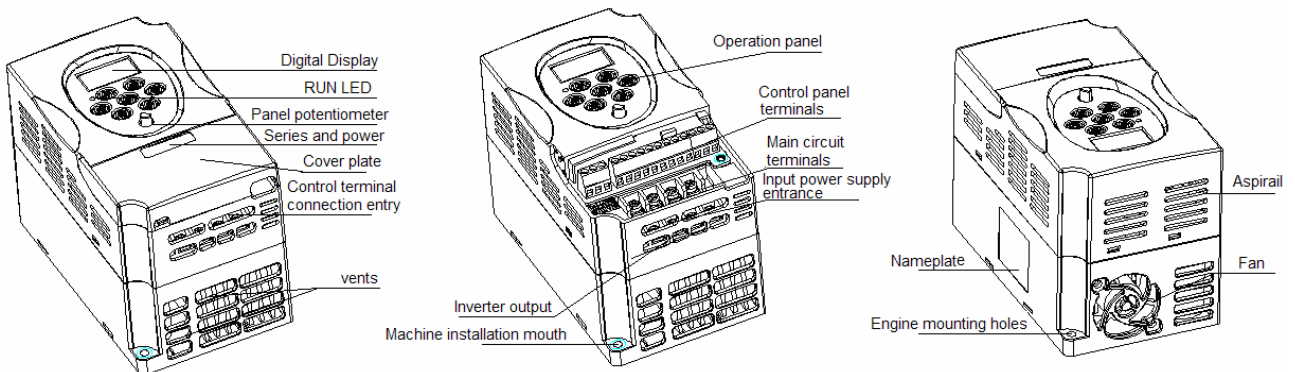

2-3 Inverter parts name

Chapter 3 Wiring Installation

3.1 Inverter overall dimensions

Application:MF10-2S0.4GS~1.5GS, MF10-4T0.75GS~2.2GS

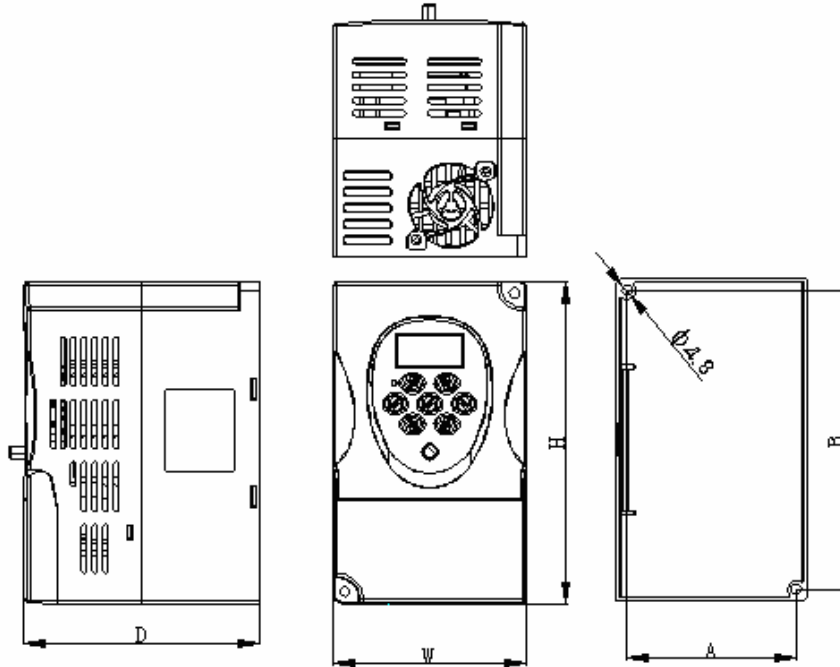

3-1 Boundary dimension

Application:MF20-2S0.4GS~2.2GS, MF20-4T0.4GS~2.2GS

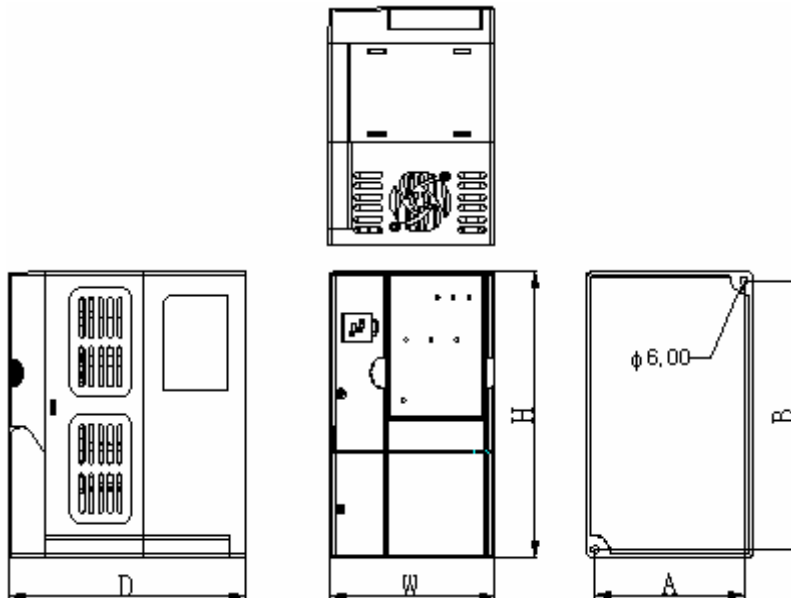

3-2 Boundary dimension

Application:MF20-4T4GS~11GS

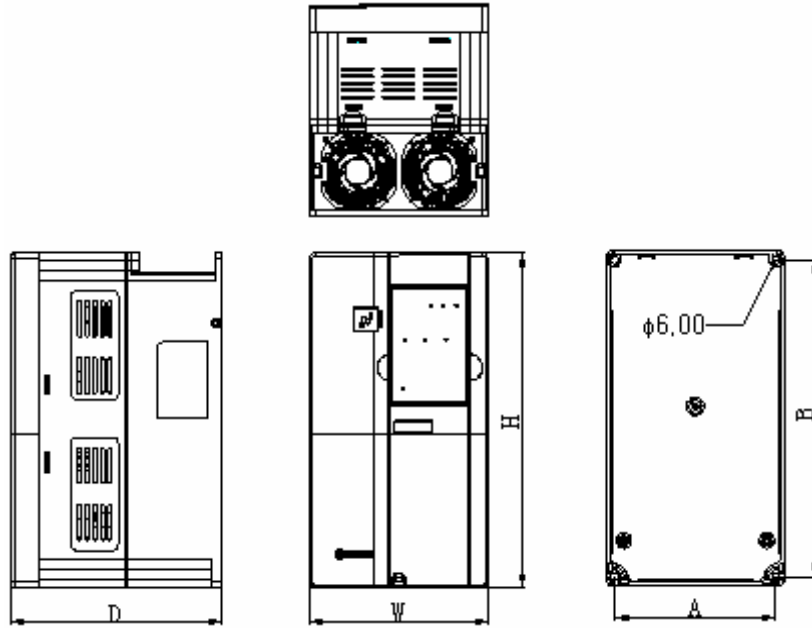

3-3 Boundary dimension

Chart 3-1 Dimension

Model	Structural type of code	A(mm)	B(mm)	H(mm)	W(mm)	D(mm)	Diameter of mounting recess(mm)
		Installation dimension		Boundary dimension			
MF10G-2S0.4GS	A1	79	139	150	90	110	4.8
MF10G-2S0.75GS							
MF10G-2S1.5GS							
MF10G-4T0.75GS							
MF10G-4T1.5GS							
MF10G-4T2.2GS							
MF20G-2S0.4GS	B1	94	169	180	105	150	6
MF20G-2S0.75GS							
MF20G-2S1.5GS							
MF20G-2S2.2GS							
MF20G-4T0.4GS							
MF20G-4T0.75GS							
MF20G-4T1.5GS	B2	126	246	260	140	165	6
MF20G-4T4GS							
MF20G-4T5.5GS	B3	154	305	320	170	193	6
MF20G-4T7.5GS							
MF20G-4T11GS							

3.2 Installation of interval and distance

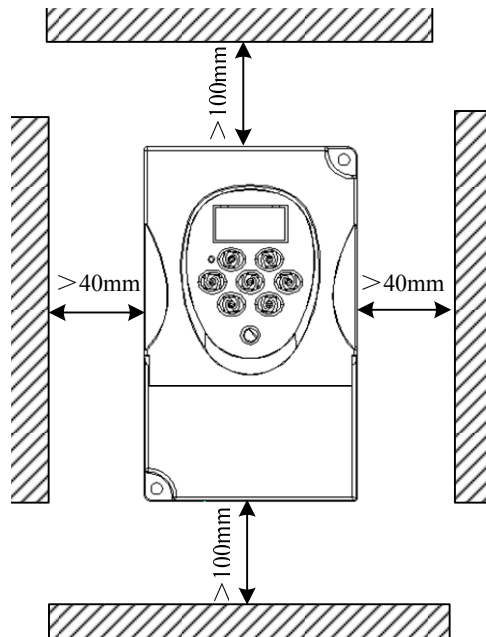

3-4 Inverter installation safety distance map

3.3 Description of Main Circuit wiring and Terminals

3.3.1 Description of MF10 single/three phase inverter terminals

MF10-2S0.4GS~1.5GS single-phase Main circuit terminals:

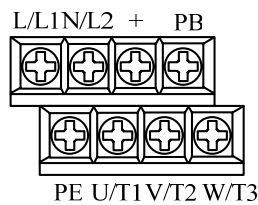

3-5 Main circuit terminals

Description of main circuit terminals:

Terminal	Function declaration
L/L1、N/L2	Main circuit 220V power input terminals
U/T1、V/T2、W/T3	Three-phase output terminals (motor)
+、PB	Reserved external braking resistor terminals
PE	Earth terminal

MF10-4T0.4GS~2.2GS three-phase Main circuit terminals:

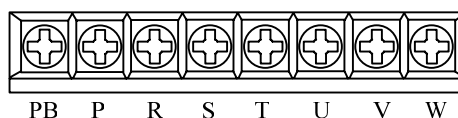

3-6 Main circuit terminals

Main circuit terminals:

Terminal	Function declaration
R、S、T	Main circuit three-phase power input
U、V、W	Three-phase output terminals (motor)
P、PB	Reserved external braking resistor terminals

3.3.2 Description of MF20 single/three phase inverter terminals

MF20-2S0.4GS~11GS、MF20-4T0.4GS~11GS main circuit terminals:

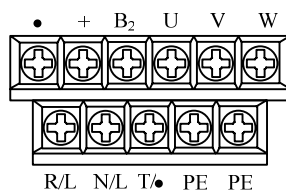

3-7 Main circuit terminals

Description of main circuit terminals:

Terminal	Function declaration
R、S、T	Main circuit three-phase power input
L、N	Single-phase power input (T terminal without)
U、V、W	Three-phase output terminals (motor)
B2、+	Reserved external braking resistor terminals
PE	Earth terminal

3.3.3 The inverter system main circuit terminal wiring and grounding

- Circuit breaker MCCB or leakage switch
With short circuit protection, overload protection function.
- Electromagnetic contactor
Contactor only to control the power supply, can't be used to directly control the start and stop of frequency converter.
- AC input reactor
When the AC input side converter and power between higher harmonic is bigger, can not meet the requirement of the system, can add AC input reactor.
- Input EMI noise filter
Optional EMI filter to suppress the high frequency noise interference from inverter power supply cord.
- Output EMI noise filter
Optional EMI filter to suppress the output side of the inverter noise interferences and wire leakage current.
- Output AC reactor
When the inverter to motor connection more than 60 meters, suggest to install AC output reactor. To avoid electrical insulation damage, leakage flow and inverter frequency protection.
- Safety ground
Inverter within the leakage current, in order to ensure the safety, the inverter and motor must be grounded, grounding resistance should be less than 10 Ω.

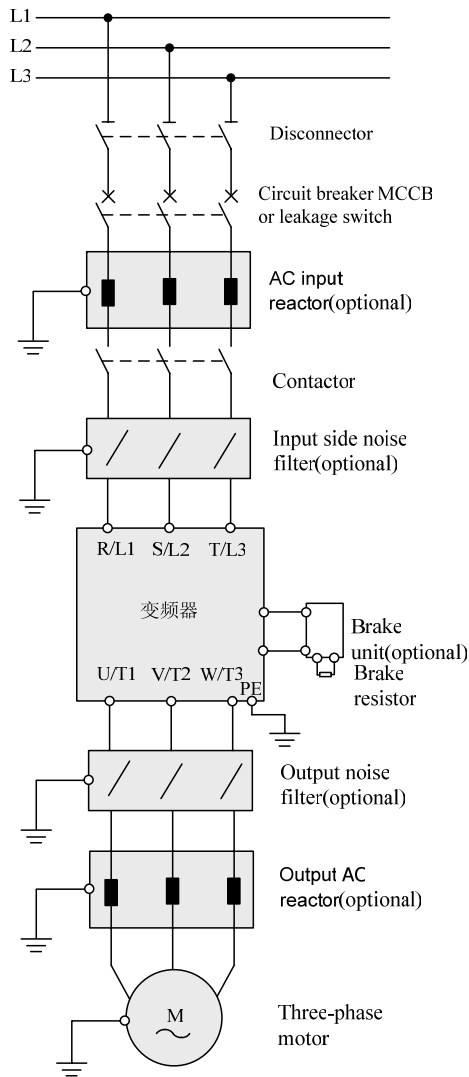

3-8 The inverter and the peripheral equipment standard connection diagram

Notice

- ◆ Do not install capacitance or surge suppressor in the inverter output side, otherwise easy to damage.
- ◆ Communication lines need to use twisted-pair shielded wire.

Grounding:

Terminal \oplus PE, this terminal must be reliably connected to the main earthing conductor.

Ground wire do not share with welding machine and power equipment, etc.

Ground wire, please use the specifications stipulated in the technical standards of electrical equipment, and with the pick up location as short as possible.

Using two or more inverters at the same time, do not use ground wire forming circuit.

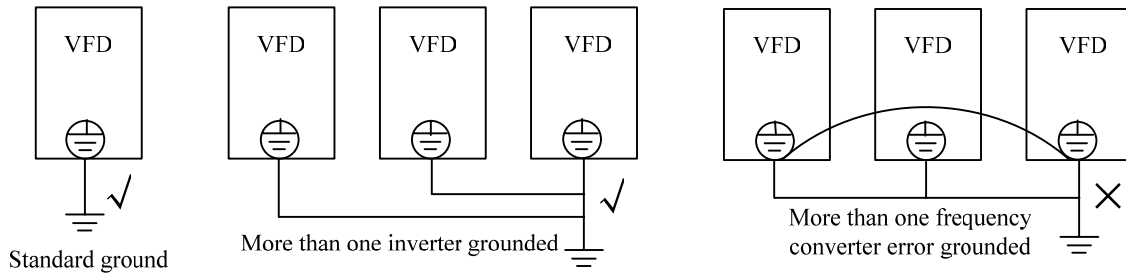

3-14 Inverter grounding diagram

The inverter and motor wiring diagram and the matters needing attention:

- Is absolutely forbidden to will power output terminals.
- Do not directly touch output terminals, or to match the output and inverter shell sub, otherwise there will be a risk of electric shock and short circuit.
- Absolute ban the use of phase shift capacitor.
Absolute ban the use of electromagnetic switch.
- In order to switch the power frequency power supply and set the electromagnetic contactor, must ensure that the inverter and motor stop to switch
- Motor used in for the first time or place for a long time before using should be tested for motor insulation inspection, prevent damage to the inverter for motor winding insulation failure. When testing, please use 500v voltage megohmmeter, should guarantee the measured insulation resistance is not less than 5 mΩ.

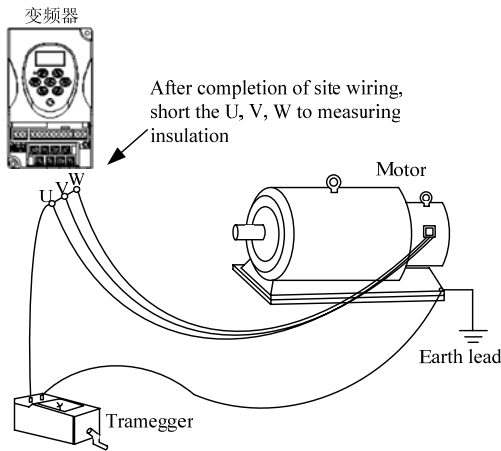

3-10 The motor insulation test

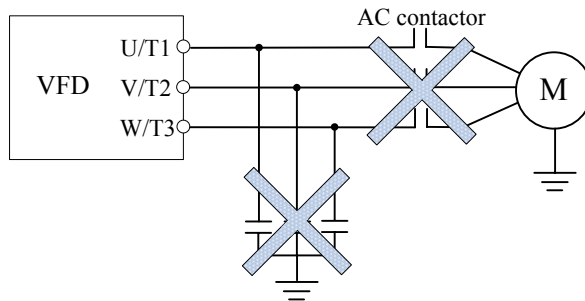

3-11 The inverter output is prohibited to use capacitor diagram

3.4 The inverter control circuit wiring and terminals

3.4.1 Description of MF10 series inverter control circuit terminal

Control circuit terminal:

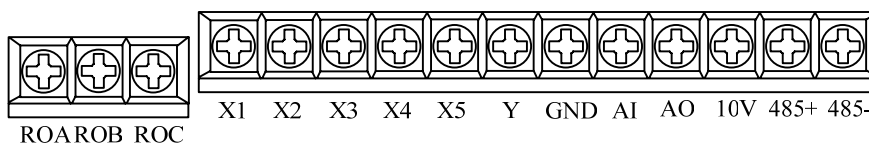

3-12 Control circuit terminal diagram

Description of control circuit terminals:

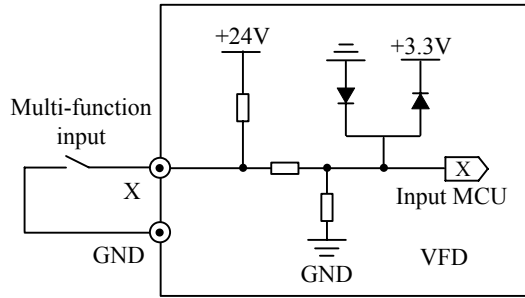
Type	Terminal Symbol	Function description	Specification
Communication terminal	RS485+	485 Positive differential signal	Standard RS - 485 communication interface Please use the twisted-pair shielded wire
	RS485-	485 Negative differential signal	
Analog input	AI	Analog input voltage/current GND	AI1 input:0~10V or 4~20mA Through the short jumper J2 / J5 choice Input resistance: It is 20KΩ at the time of voltage input and 500Ω at the time of current input ; error ±1%,30℃
Analog output	AO	Analog voltage output GND	Output 0~10V Error±1%, 30℃
on-off input	X1~X5	Multi-function input terminal GND	Input resistance:4.3KΩ Maximum input frequency:200Hz 
10V power	10V	Provide reference 10v power	The maximum output current 40mA
10V COM	GND	Analog signal and 10V GND	GND
on-off output	Y	Multi-function terminal output	NPN switch output,0~ 50 mA
Relay output	ROA/ ROB/ ROC	Multi-function relay output	220~250VAC 3A; 24A~30VDC 3A original state :ROA-ROC NC;ROB-ROC NO

MF10 series single-phase inverter basic wiring:

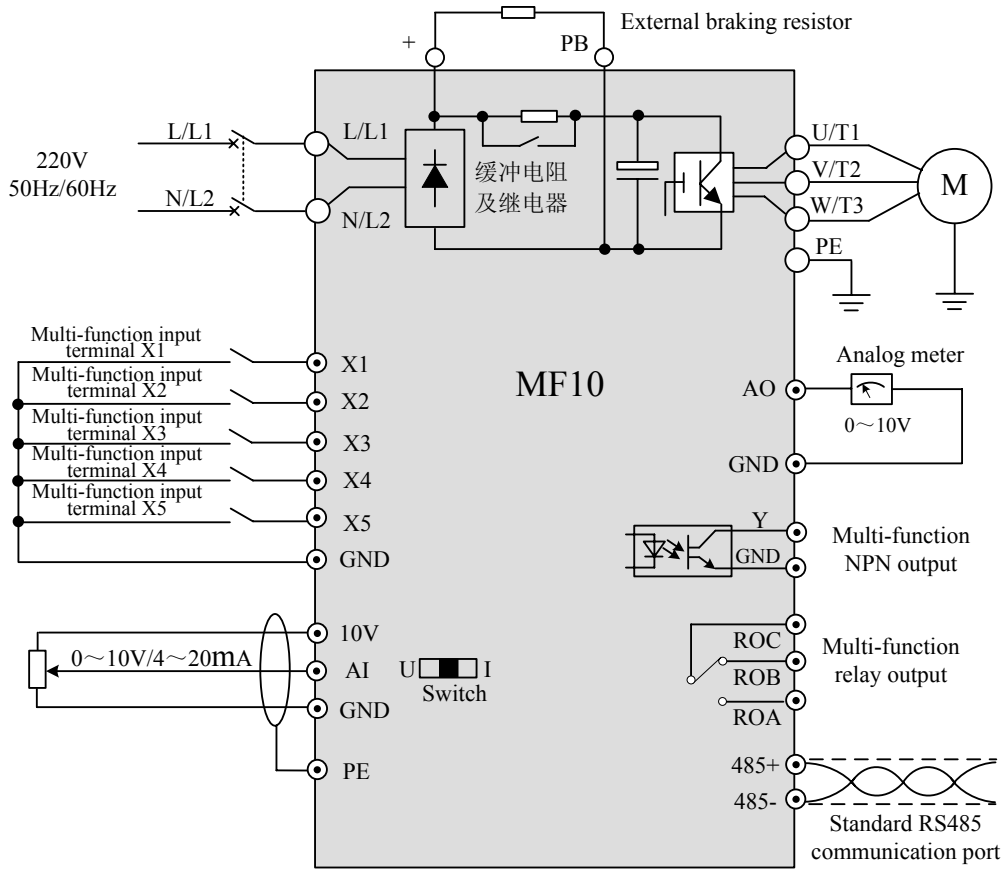

3-13 Inverter basic wiring diagram

MF10 series three-phase inverter basic wiring:

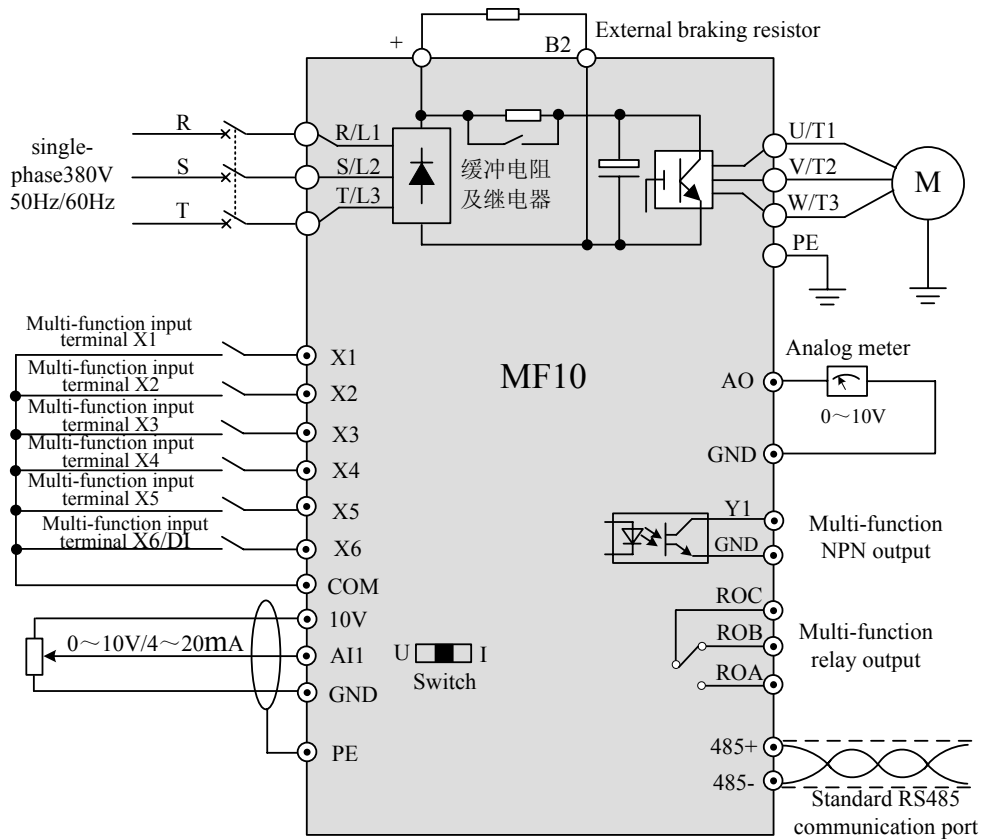

3-14 Inverter basic wiring diagram

3.4.2 Description of MF20 series inverter control circuit terminal

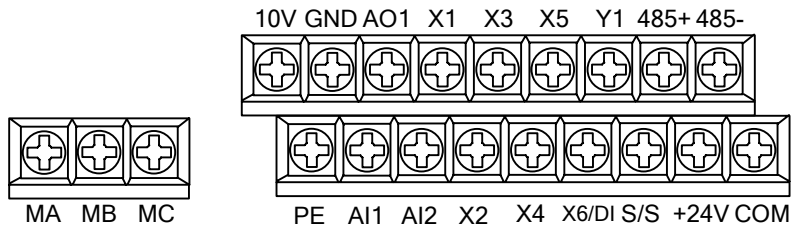

3-15 Control circuit terminal diagram

Description of control circuit terminals:

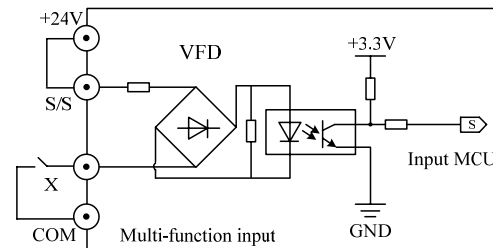
Type	Terminal Symbol	Function description	Specification
Communication terminal	RS485+	485 Positive differential signal	Standard RS - 485 communication interface Please use the twisted-pair shielded wire
	RS485-	485 Negative differential signal	
Analog input	AI1、AI2	Analog input voltage/current(AI2 only supports the input voltage) GND	Input 0~10V or 4~20mA Input resistance: It is 120KΩ at the time of voltage input and 25kΩ at the time of current input ; error ±1%,30°C
Analog output	AO1	Analog voltage output GND	Output 0~10Vor 4~20mA error±1%,30°C
On-off input	S/S	Multi-function input terminal X1 ~ X8 public side	Input impedance: 4..3KΩ Maximum input frequency:200Hz 
	X1~X6	Multi-function input terminal GND	
+24V power	+24V	Provide reference 24v power	The maximum output current 40mA
24V GND	COM	24V GND	
+10V power	+10V	Provide reference power 10v	The maximum output current 40mA
10VGND	GND	Analog signal and 10v GND	Segregate inside and COM
On-off output	Y1	Multi-function terminal output	NPN switch output
Relay output	ROA/ ROB/ ROC	Multi-function relay terminal output	220~250VAC 3A; 24~30VDC 3A Original state :ROA-ROC NC;ROB-ROC NO
GND	PE	GND	Internally connected to the terminals of main loop PE

MF20 series single/three phase inverter basic wiring:

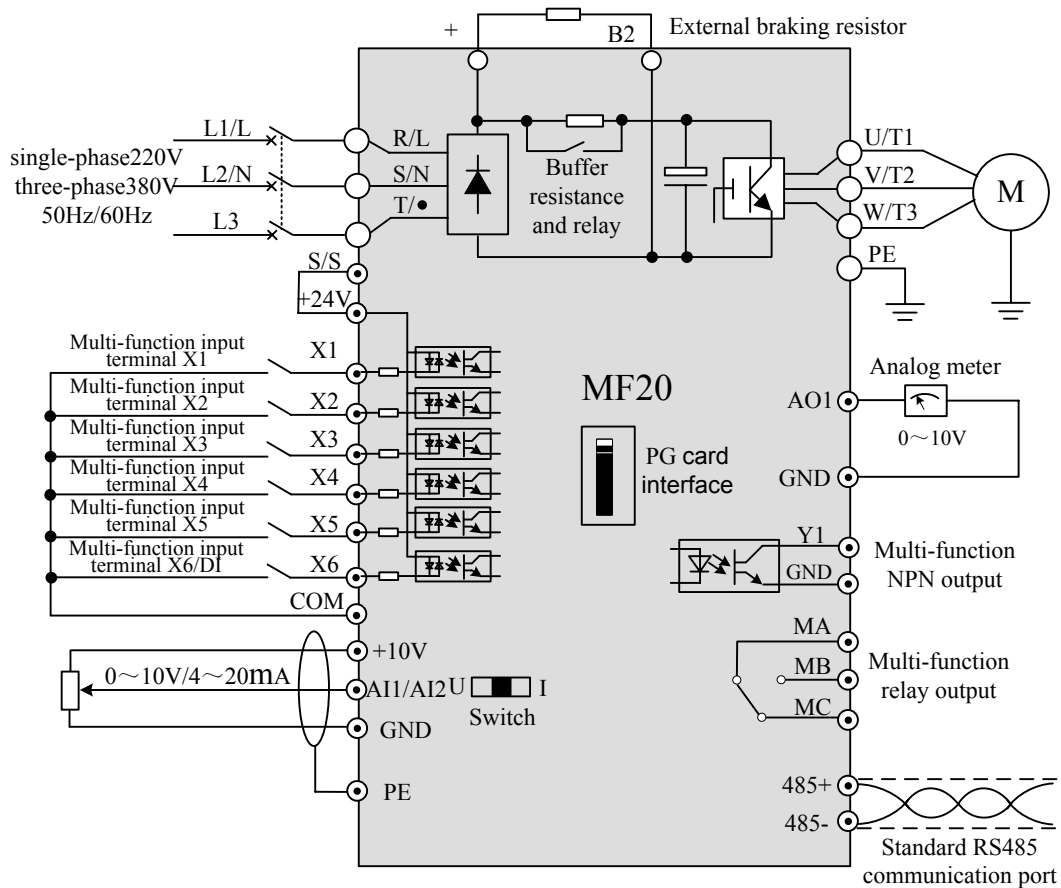

3-16 Inverter basic wiring diagram

3.4.3 The related instructions of control circuit

On-off input:

- ◆ On-off input: internal connection 24V power supply, the input and GND effective circuit and the input impedance of 10K.
- ◆ When using analog input, it can be installed filter or common-mode inductor between AI and GND.
- ◆ When using a shielded cable, cable shielding layer of proximal (close to one end of the inverter) should be connected to the inverter earthing terminal of PE.
- ◆ Walk line twisted-pair shielded wire should be fully away from the main circuit and high voltage lines.

On-off output:

- ◆ Inverter using the power converter Y port voltage $\leq 30V$, current $\leq 0.5A$.

Analog input:

- ◆ When analog input terminal AI choosing voltage input: input 0~10V.
- ◆ When analog input terminal AI choosing current input: input 4~20mA.
- ◆ Analog signal easily disturbed, so the shield grounding.

Analog output:

- ◆ Analog output: voltage 0~10V.
- ◆ Analog signal easily disturbed, so the shield grounding.

Relay:

- ◆ MF10 inverter relay when AC250V for 3A maximum load current; In 28V DC for 3A maximum load current;
- ◆ When using a relay drive inductive load, should be equipped with surge voltage absorbing circuit, varistor, or fly-wheel diode to absorb the current when on-off. Absorbing circuit components will be installed in relay side.

3.4.4 Communication wiring

Inverter with RS485 interface communication:

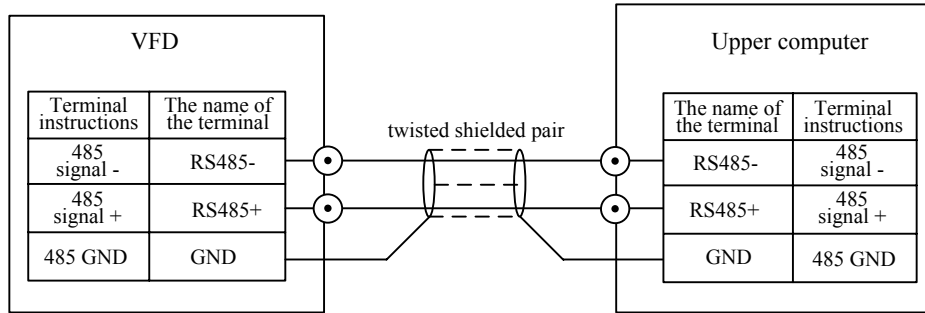

3-17 RS485 and RS485 communication wiring

Inverter with RS232 communication interface:

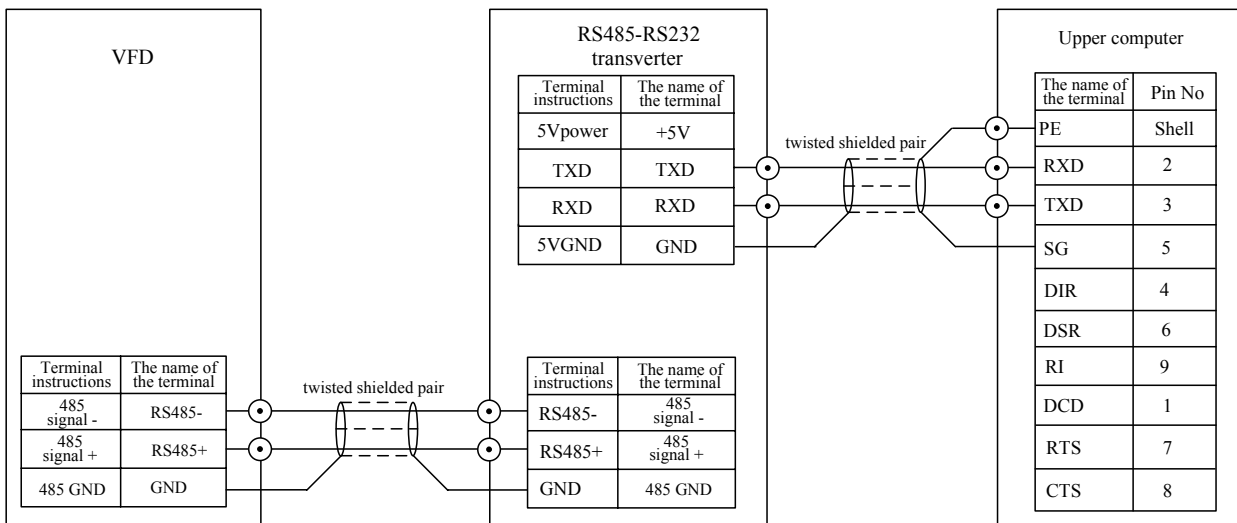

3-18 485 and RS232 communication wiring

More than one inverter articulated in the same RS485 system wiring:

More than one inverter to hook up in the same RS485 system, communication interference enhancement, wiring is very important, recommend the user according to the following way connection:

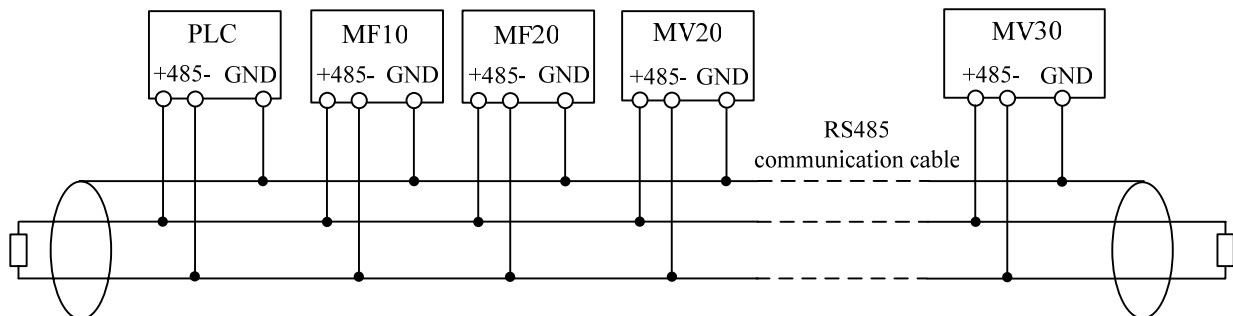

3-19 Wiring diagram

 **Note**

- ◆ It is recommended to use standard 485 communications.
- ◆ Please use the standard twisted-pair shielded wire.
- ◆ Walk line twisted-pair shielded wire should be fully away from the main circuit and high voltage lines.
- ◆ When the communication line is too long suggested that communication line with terminal resistance.

3.5 The MF series inverter system configuration scheme

3-2 The MF series inverter system configuration scheme

Inverter type	Brake unit	Braking resistor unit		Braking torque
		Brake resistor	Number	
MF10G-2S0.4GS	Standard built-in	200Ω/70W	1	220
MF10G-2S0.75GS		200Ω/70W	1	125
MF10G-2S1.5GS		100Ω/260W	1	125
MF10G-4T0.75GS		750Ω/70W	1	130
MF10G-4T1.5GS		400Ω/260W	1	125
MF10G-4T2.2GS		250Ω/260W	1	135
MF20G-2S0.4GS		200Ω/70W	1	220
MF20G-2S0.75GS		200Ω/70W	1	125
MF20G-2S1.5GS		100Ω/260W	1	125
MF20G-2S2.2GS		700Ω/260W	1	120
MF20G-4T0.75GS		750Ω/70W	1	130
MF20G-4T1.5GS		400Ω/260W	1	125
MF10G-2S0.4GS		200Ω/70W	1	220
MF10G-2S0.75GS		200Ω/70W	1	125
MF20G-4T2.2GS	Standard built-in	250Ω/260W	1	135
MF20G-4T4GS		150Ω/390W	1	135
MF20G-4T5.5GS		100Ω/520W	1	135
MF20G-4T7.5GS		75Ω/780W	1	130
MF20G-4T11GS		50Ω/1040W	1	135

 **Attention**

- ◆ Please in accordance with the data provided by the company to choose the braking resistor value and power.
- ◆ When using external braking unit, properly set brake unit brake voltage grade, such as voltage level setting is not correct, will affect the normal operation of the inverter.

The brake component options guide:

Table 3-8 provides data for reference. You can select different resistance and power based on actual needs. However, the resistance must not be lower than the recommended value. The power may be higher than the recommended value.

Physical Dimensions of External DC Reactor:

The motor and load's regenerative energy is almost completely consumed on the braking resistor when braking.

According to the formula $U \times U/R = P_b$:

- U refers to the braking voltage at system stable braking.

Different systems select different braking voltages. The 380 VAC system usually selects 700 V braking voltage.

- P_b refers to the braking power.

Selection of Power of Braking Resistor:

In theory, the power of the braking resistor is consistent with the braking power. But in consideration that the de-rating is 70%, you can calculate the power of the braking resistor according to the formula $0.7 \times P_r = P_b \times D$.

- P_r refers to the power of resistor.
- D refers to the braking frequency (percentage of the regenerative process to the whole working process)

General application---10%

Elevator-----20% ~ 30%

Winding and unwinding--20% ~ 30%

Centrifuge-----50% ~ 60%

Chapter 4 The operation of the keyboard

4.1 Operation panel is introduced

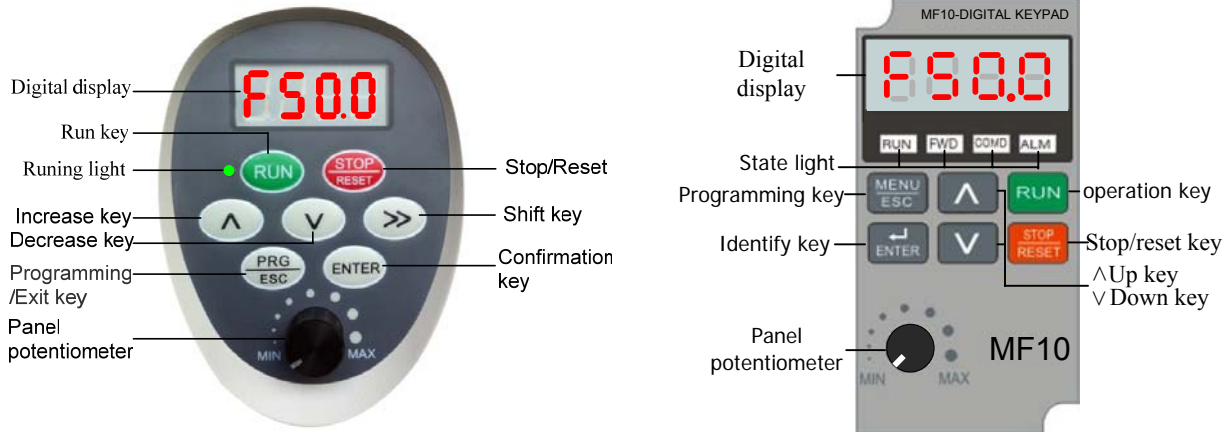

4-1 MF10 panel key indicator diagram

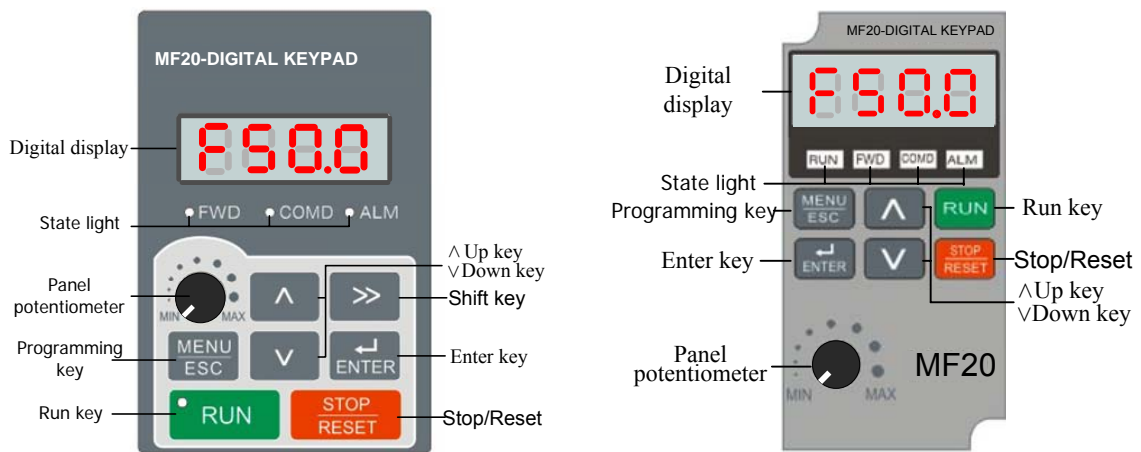

4-2 MF20 Panel key indicator diagram

4.1.1 Panel display shows



Indicator description:

Run the light show that the motor forward; Running lights went out show that the motor stop; Running lights flashing show that the motor reversal.

LED display:

Four LED display, can display setting frequency, output frequency, all kinds of monitoring data and alarm code, etc.



Description of display item:

Display item	Description
	If the character does not flicker, show that displays the current output frequency of the motor; if flashing character, it shows that show the current setting frequency
	According to the output side of U/T1、V/T2、W/T3 output current

Display item	Description
	According to the output voltage
	According to frequency converter bus voltage
	Displays the percentage of the output power
	Display output power factor percentage
	According to the AI output voltage, Display panel potentiometer voltage
	Displays the percentage of AI curve adjustment, The percentage of the display panel potentiometer by the curve
	Switch terminal and status display
	Display terminal count
	Display PLC running stage
	Shows the closed loop feedback, closed loop setting (flash), closed-loop output,the percentage of the closed-loop error(you need to use the shift key can display hidden)
	Displays the inverter overload or motor overload the percentage of the total (you need to use the shift key can display hidden)
	According to the temperature of the inverter
	Show the current motor running speed(You need to use the shift key can display hidden place)
	According to the currently running linear velocity

4.1.2 Keyboard button description

Key	Name	Function
	Run key	It is used to start the inverter under keyboard control mode.
	Stop/Reset	Press this button to stop in the running status and reset the operation in the fault alarm status.
	Increase key	increase of the data or function code
	Decrease key	decrease of the data or function code
	Shift key	Select the displayed parameters in turn on the stop display interface and running display interface, and select the modification digit of parameters when modifying

Key	Name	Function
		parameters.
	Programming/Exit key	Enter into/ exit from level 1 menu
	Confirmation key	Enter the menu interfaces level by level, and confirm the set parameters.
	Panel potentiometer	Panel potentiometer analog given

4.2 Function parameter setting method

4.2.1 Description of inverter function block



There are 17 group function code of MF10 series inverter, each functional group including several function codes, Function code with the method of function block number + function code identification, such as P5.08 is expressed as the no.8 function code of the fifth group.





Parameter Groups	Description	Parameter Groups	Description
P0	Basic function parameters	PA	Pendulum frequency operation parameters
P1	V/F controls parameter	Pb	Status surveillance
P2	Running auxiliary parameters	PC	Failure record
P3	Control enhancement parameters	Pd	System configuration management
P4	Protect parameter Setting	PU	Communication Parameters
P5	Digital quantity function parameter	Ph	Communication address mapping parameters
P6	Analog function parameter	Pn	Communication save parameters
P7	Multistage parameters	PE	Motor data
P8	Simple PLC	PF	Manufacturer parameters
P9	PID process closed-loop parameters		

1. LED display function code parameters menu structure

MF10 series inverter has two levels of menu are:

- 1)Function parameter and function code label(level 1 menu)
- 2)Function code setup value(level 2 menu)

Note: When operating on level 2 menu, press “  ” key or “  ” key to return to level 1 menu. The difference

between “  ” key and “  ” key is described as follows:Pressing “  ” key will save the setup parameter to control board and return to the level 1 menu and automatically shift to the next function code;while pressing “  ” key will directly return to level 1 menu without saving the parameter, and it will return to the current function code.

2. LED display function code parameter menu mode

MF10系列变频器有三种菜单模式:基本菜单模式、高级菜单模式、出厂值比较模式。

MF10 series inverter there are three kinds of menu modes: basic menu mode, advanced models, factory value

comparison.

Can also set the function code by Pd. 01 (menu) to switch the parameters, different parameter mode, display the function of different parameter set.

3. Function code parameter setting Instance

Parameter Settings are divided into decimal (DEC) and hexadecimal (HEX) two kinds, If the parameter is expressed in hexadecimal editor when you separate, Part of a range of values can be hexadecimal (0 ~ F).

Example: P0.16 set parameters of 5.00 Hz.

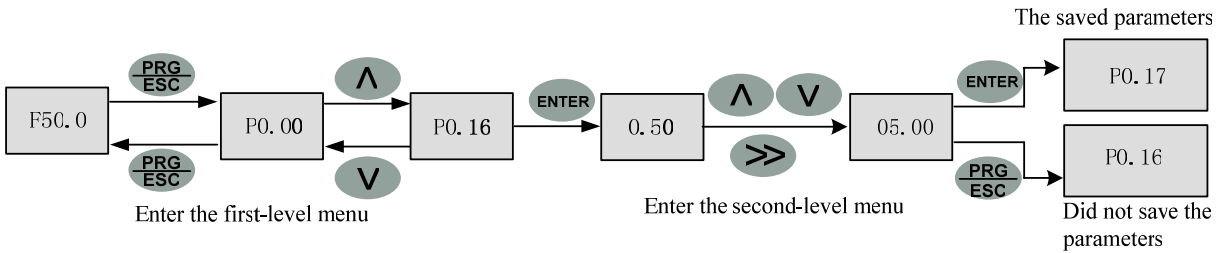

Example: hex parameter setting method

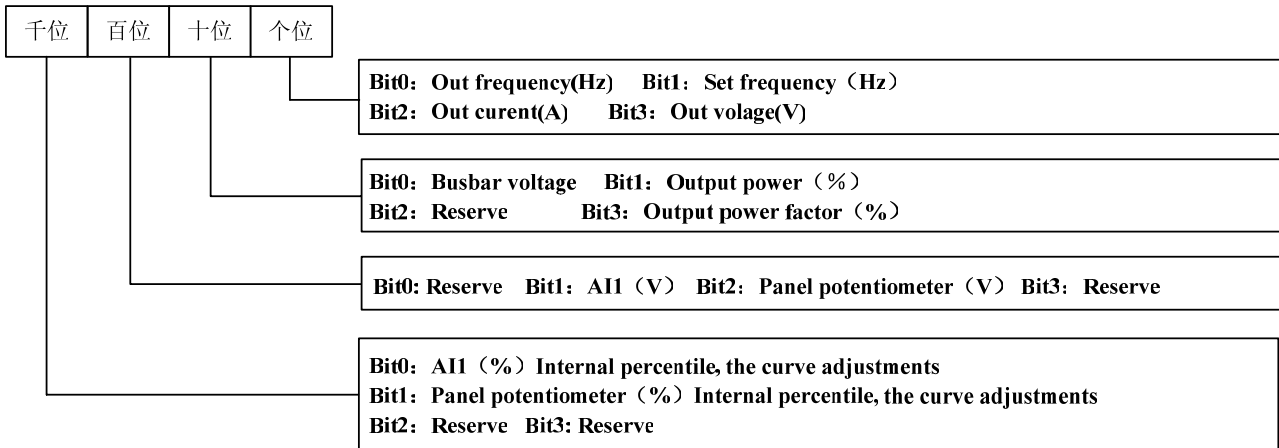

With Pd.10 run LED display parameters, for example, if you require the keyboard display output frequency, busbar voltage, output power.

Set various parameters, such as Bit0 = 1 shows that the parameters, the parameters displayed does not require the corresponding bit is set to 0. Refer to the above:

Set the bits value:

Output frequency by Pd. 10 bits Bit0 decided, so bits for 0001, converted to hexadecimal is 1, so bits should be set to 1.

Set up ten value:

Bus voltage and the output power by Pd. 10 Bit0 and Bit1 decision, so ten to 0011, converted to hexadecimal 3, so ten should be set as 3.

One hundred and one thousand - bit values:

Requirements according to the parameters of the no one hundred and one thousand, one hundred and one thousand - bit is set to zero.

To sum up, Pd. 10 to 0031.

 **Note**

In any level menu state, if the parameter is not flashing, said the function code cannot be modified, possible reasons are:

- ◆ This function code is not modify parameters. Such as the actual testing parameters, operation records, etc.
- ◆ The function code under running immutable, need to stop to modify.
- ◆ Parameters are protected. When the function code Pd. 02 to 0 or 1, the function code are immutable, the operating parameters to avoid error protection. If you want to edit work can code parameters, need to function code Pd.02 set to 2.

4.2.2 Inverter password Settings

In order to protect the parameter, inverter provides password protection function. Set the user password, the user input user password must be correct, after press “  ”key to enter into the state of function code editor. For the factory area set parameters, still need to input the factory correct password.



When need the user password, set the Pd. 00 for any nonzero number, and press“  ” key to confirm, if after this row 1 minutes without any key operation, the password protection function to take effect. When does not need the user password, the Pd. 00 to 0000, after this if without any key operation continuous 1 minute, password protection function to take effect.



 **Note**

- ◆ Please do not attempt to modify the manufacturer set parameters, If the parameter Settings,easy to cause the inverter work abnormal or even damage.
- ◆ After the correct input user password, if 1 minutes without keystrokes, password protection will be locked again.

4.2.3 Lock and unlock operation panel

Through the function code Pd. 03 kilobit can be set the lock operation panel.

Press “  ” button and keep, and then press the “  ” key, LED display “  ” lock has operation panel.

When all operation panel button is locked, can be unlocked by the following: press “  ” button and keep, and then press B three times in “  ” row.

 **Note**

- ◆ No matter before Pd.03 set, frequency converter after each access to electricity, operation panel are not locked.

4.3 The inverter to electricity

Before power on check: according to "inverter wiring" in this manual provides the operation requirements of aircraft wiring connections.

After first electrical operation: sure the wiring is correct, with electricity, digital tube display “**8.8.8.8.**” frequency

converter, contactor, and the normal suction when digital tube display to set frequency, shows that frequency converter has initialization is complete.

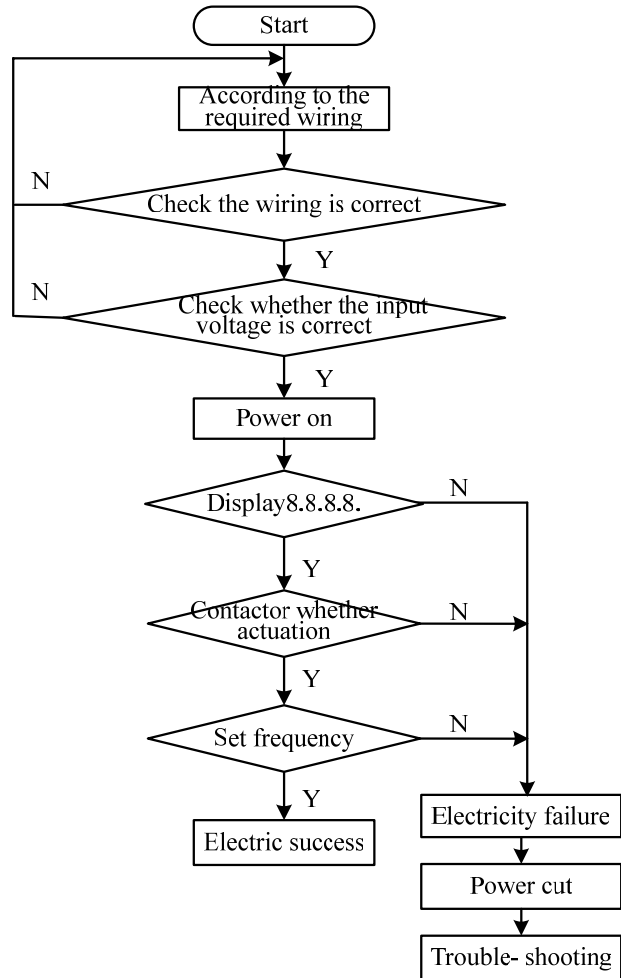

4-2 Electrical operation frequency converter for the first time

Chapter5 Function parameter profiles

5.1 Function parameter profiles

Function code	Functions within the group number and group number, such as P01.02 is 0 group, 02 function code
Name of the function code	The name of the function code, explain the function of the function code
Stting range	Function code minimum to the maximum effective set range
Factory	The factory setting of the function code
Parameters in detail	Parsing the meaning represented different function code parameter values
Unit	The unit of function code: V-voltage; A-current; Hz, KHz-frequency; rpm-Speed; KW-power; °C-temperature; ms, s, min, h, kh-time; %-percentage; bps-Baud rate; kgm/s ^ 2-moment of inertia; /-No unit
Change	Function code allows parameter change of conditions: ○-The parameter can be modified when the AC drive is in either stop or running state. ×-The parameter cannot be modified when the AC drive is in the running state. *-The parameter is the actually measured value and cannot be modified.
Communication address	Modbus and MXLinkmailing address, In the table for hexadecimal display
Basic menu item	√-Basic menu contains the function code; ×-Basic menu does not contain the function code

Function code	Name of parameter	Set Range	Factory	Basic menu	Change	Mailing address
P0 The basic function parameters						
P0.00	Master of a given frequency number given	0.00~400.00	30.00	√	○	0000
P0.01	Run command channel choice	0:operation panel 1:Terminal command channel 2:Modbus/MXLink communication control	0	√	○	0001
P0.02	A frequency command	0: Keypad 1: terminal AI 2: Panel potentiometer	0	√	○	0002
P0.03	B frequency command	3:Simple PLC 4:Multi-speed 5:Process closed-loop 6:Modbus/MXLink communication setting	1		○	0003
P0.04	B frequency command reference	0: Refer to maximum output frequency, 100% corresponding to maximum output frequency Refer to A set frequency,100%	0	×	○	0004

Function code	Name of parameter	Set Range	Factory	Basic menu	Change	Mailing address
		corresponds to A set frequency				
P0.05	Combination of the setting	0: Set the mode A 1: Set the mode B 2: Set the mode A+ Set the mode B 3: Set the mode A- Set the mode B 4: The bigger one between the mode A and B 5:The least one between the mode A and B	0	×	○	0005
P0.06	Running direction	0: Forward 1: Reversal	0	×	○	0006
P0.07	Acceleration time 1	0.1~3600.0	6.0	√	○	0007
P0.08	Deceleration time 1	0.1~3600.0 L	6.0	√	○	0008
P0.09	Reserve					
P0.10	Reserve					
P0.11	Maximum output frequency	Max(50.00,P0.13)~400.00	50.00	×	×	000B
P0.12	Frequency lower limit	0.00~P0.13(Frequency upper limit)	0.00	×	×	000C
P0.13	Frequency upper limit	P0.12(Frequency lower limit)~400.00	50.00	×	×	000D
P0.14	Inching operation frequency	0.01~60.00	5.00	×	○	000E
P0.15	Start-up mode	0:From the starting frequency starting 1:First DC brake,then start 2: Reserve	0	√	×	000F
P0.16	Startup frequency	0.00~P0.13(Frequency upper limit)	1.00	×	×	0010
P0.17	Startup frequency holding time	0.00~600.00	0.00	×	×	0011
P0.18	Startup DC braking current	0.0~100.0	50.0	×	×	0012
P0.19	Startup DC braking time	0.00~30.00	0.00	×	×	0013
P0.20	Stop mode	0: Decelerate to stop 1: Coast to stop	0	√	×	0014
P0.21	Initial frequency of stop DC braking	0.00~P0.13(Frequency upper limit)	1.00	×	×	0015
P0.22	Waiting time of stop DC braking	0.00~10.00	0.00	×	×	0016
P0.23	Stop DC braking current	0.0~100.0	50.0	×	×	0017
P0.24	Stop DC braking time	0.00~30.00	0.00	×	×	0018
P0.25	Anti-reverse choice	0: Allow the reversal 1: Ban reversal	0	×	×	0019
P0.26	Forward/Reverse rotation dead-zone time	0.00~600.00	0.00	×	×	001A

Function code	Name of parameter	Set Range	Factory	Basic menu	Change	Mailing address
P0.27	Forward/Reverse switching mode	0: Switch on the zero frequency 1: Switch after the starting frequency	0	×	×	001B
P0.28	Restart after power off	0: Disable 1: Enable	0	×	×	001C
P0.29	The waiting time of Restart after power off	0.00~60.00	0.00	×	×	001D
P0.30	Timing downtime	0.0~650.00	0.00	○	×	001E
P0.31	Timing set downtime	Unit's digit: Downtime source 0:Timing downtimeP0.30 1:AI1 2: Panel potentiometer AI 100%Correspond to the time P0.30 Ten's digit: Downtime unit 0:s 1:min 2:hour Hundred's digit:Timer stop action keep 0: stoping, timer reset 1: stoping, timer keep	0x000	○	×	001F
P0.32	Running time preset values	0.00~650.00	0.00	○	×	0020
P1 V/F control parameter						
P1.00	V/F curve to choose	0: Straight line V/F curve 1: Multi-point V/F 2~11:1.1~2.0 Power down torqueV/F	0	√	×	0400
P1.01	V/F frequency 1	0.00~P1.03(V/F frequency 2)	0.00	×	×	0401
P1.02	V/F voltage 1	0.0~P1.04(V/F voltage 2)	0.0	×	×	0402
P1.03	V/F frequency 2	P1.01(V/F frequency 1) ~ P1.05(V/F frequency 3)	0.00	×	×	0403
P1.04	V/F voltage 2	P1.02(V/F voltage 1)~P1.06(V/F voltage 3)	0.0	×	×	0404
P1.05	V/F frequency 3	P1.03(V/F frequency 2) ~ P1.07(V/F frequency 4)	0.00	×	×	0405
P1.06	V/F voltage 3	P1.04(V/F voltage 2)~P1.04(V/F voltage 4)	0.0	×	×	0406
P1.07	V/F frequency 4	P1.05(V/F frequency 3)~P0.11(Maximum output frequency)	0.00	×	×	0407
P1.08	V/F voltage 4	P1.06(V/F voltage 3)~100.0	0.0	×	×	0408
P1.09	AVR function	0: Forbid AVR 1: Enable AVR	1	×	×	0409
P1.10	Torque compensation	0.0: AUTO Torque compensation 0.1~30.0: Manual Torque compensation	0.0	×	○	040A
P1.11	Cut-off frequency of	0.0~30.0	10.0	×	○	040B

Function code	Name of parameter	Set Range	Factory	Basic menu	Change	Mailing address
	torque boost					
P1.12	V/F slip compensation gain	0.0~200.0	100.0	×	○	040C
P1.13	V/F slip compensation Limit	0.0~300.0	200.0	×	○	040D
P1.14	V/F slip compensation Prop filter	0.001~10.000	2.000	×	○	040E
P1.15	Oscillation suppression gain	0.00~10.00	1.00	×	○	040F
P2 Run auxiliary parameters						
P2.00	Frequency keyboard auxiliary source selection	0: Keypad/\set 1: Terminal UP/DOWN set	0	×	○	0500
P2.01	Frequency keyboard auxiliary controls	Units' digit: 0: Frequency power no storage 1: Frequency power storage Ten's digit: 0: Stop fine-tuning history keep 1: Stop fine-tuning history reset	0x00	×	○	0501
P2.02	Run the command channel bundling frequency channel	units' digit: Operation panel control command 0: No bound 1: Keypad setting 2: Terminal AI setting 3: Panel potentiometer setting 4: Simple PLC 5: Multi-speed 6: PID 7: Modbus/MXLink communication setting Ten' digit: Terminal command control ditto Hundred's: Modbus/MXLink command control ditto	0x000	×	○	0502
P2.03	Linear velocity coefficient	0.1~400.0	1.0	×	○	0503
P2.04	Linear velocity coefficient					
P2.05	Jump frequency 1	0.00~400.00	0.00	×	×	0505
P2.06	Frequency 1 jump amplitude	0.00~30.00	0.00	×	×	0506
P2.07	Jump frequency 2	0.00~400.00	0.00	×	×	0507
P2.08	Frequency 2 jump	0.00~30.00	0.00	×	×	0508

Function code	Name of parameter	Set Range	Factory	Basic menu	Change	Mailing address
	amplitude					
P2.09	Jump frequency 3	0.00~400.00	0.00	×	×	0509
P2.10	Frequency 3 jump amplitude	0.00~30.00	0.00	×	×	050A
P2.11	Acceleration time 2	0.1~3600.0	6.0	×	○	050B
P2.12	Deceleration time 2	0.1~3600.0	6.0	×	○	050C
P2.13	Acceleration time 3	0.1~3600.0	6.0	×	○	050D
P2.14	Deceleration time 3	0.1~3600.0	6.0	×	○	050E
P2.15	Acceleration time 4	0.1~3600.0	6.0	×	○	050F
P2.16	Deceleration time 4	0.1~3600.0	6.0	×	○	0510
P2.17	Switching frequency between acceleration and deceleration time 1 and 2	0.00~400.00	0.00	×	○	0511
P2.18	Switching hysteresis frequency between acceleration and deceleration time 1 and 2	0.00~30.00	1.00	×	○	0512
P2.19	S curve of time start to accelerate	0.0~10.0	0.0	×	×	0513
P2.20	Accelerate the end time of S curve	0.0~10.0	0.2	×	×	0514
P2.21	Slow start S curve	0.0~10.0	0.2	×	×	0515
P2.22	End S curve time reduction	0.0~10.0	0.0	×	×	0516
P2.23	JOG acceleration time	0.1~60.0	6.0	×	○	0517
P2.24	JOG deceleration time	0.1~60.0	6.0	×	○	0518
P2.25	JOG interval time	0.0~100.0	0.0	×	○	0519
P2.26	Emergency stop deceleration time	0.0~600.0	1.0	×	○	051A
P3 Control enhancement parameters						
P3.00	carrier frequency	1.0~10.0	8.0	×	○	0700
P3.01	Reserve					
P3.02	energy-saving operation	0: forbid 1: enabled	0	×	○	0702
P3.03	V/F Energy-saving operation coefficient	0.0~50.0	0.0	×	○	0703
P3.04	Automatic current limiting options	0: Effective acceleration and deceleration, constant speed is invalid 1: acceleration and deceleration, constant	1	×	×	0704

Function code	Name of parameter	Set Range	Factory	Basic menu	Change	Mailing address
		speed are effective				
P3.05	Automatic current limit levels	50.0~200.0	150.0	×	×	0705
P3.06	V/F current limit control gain	0.00~10.00	1.00	×	○	0706
P3.07	Function of overpressure stall	0: forbid 1: enabled	0	×	×	0707
P3.08	Stall point overvoltage	220V:350~390 380V:640~780	360 750	×	×	0708
P3.09	Over-excitation deceleration function	0: Over-excitation deceleration function 1: Inhibition of busbar voltage over-voltage, don't over excitation control 2: Inhibition of busbar voltage over-voltage, and excitation control	2	×	×	0709
P3.10	Overvoltage suppression detection value	220V:350~380 380V:640~740	360 720	×	×	070A
P3.11	Overvoltage suppression gain	0.000~4.000	1.000	×	○	070B
P3.12	Instantaneous stop function	0: forbid 1: enabled	0	×	×	070C
P3.13	Instantaneous stop detection value	220V:210~240 380V:400~480	210 450	×	×	070D
P3.14	Instantaneous stop deceleration gain	0.000~4.000	1.000	×	○	070E
P4 Protect the parameter Settings						
P4.00	Option 1 protection action	units' digit: Abnormal communication action choice 0: Protection movement and free parking 1: The alarm and continues to run ten's digit: Brake pipe abnormal action choice 0: Protection movement and free parking 1: The alarm and continues to run hundred's digit: EEPROM abnormal action choice 0: Protection movement and free parking 1: The alarm and continues to run	0x111	×	×	0900
P4.01	Option 2 protection action	units' digit: input phase action choice 0: failure to actuate 1: Protection movement and free parking 2: The alarm and continues to run ten's digit: output phase action choice	0x1111	×	×	0901

Function code	Name of parameter	Set Range	Factory	Basic menu	Change	Mailing address
		0: failure to actuate 1: Protection movement and free parking 2: The alarm and continues to run hundred's digit: Temperature detection circuit fault 0: failure to actuate 1: Protection movement and free parking 2: The alarm and continues to run Thousand's digit: In the operation of busbar undervoltage fault movements 0: failure to actuate 1: Protection movement and free parking Three-phase input model is lack of phase function				
P4.02	Fault selection indicator	units' digit: Under-voltage fault indicator action choice 0: Failure to actuate 1: Action ten's digit: Automatic reset interval fault indicator action choice 0: Failure to actuate 1: Action hundred's digit: Fault locking action choice 0: Fault locking function is prohibited 1: Fault locking function allows, but no action instructions 2: Fault locking function allows, and direct action	0x000	×	×	0902
P4.03	alarm set frequency	0: alarm frequency given is invalid 1: alarm standby frequency (P4.04) 2: The current running frequency * alarm frequency coefficients (P4.05) 3: P00.00 set frequency 4: lower rate limit (P0.12) 5: upper rate limit (P0.13)	0	×	×	0903
P4.04	alarm standby frequency	0.00~400.00(P0.11)	1.00	×	×	0904
P4.05	alarm frequency coefficient	0.0~100.0	100.0	×	×	0905
P4.06	Automatic reset number	0~100	0	×	×	0906
P4.07	Automatic reset time interval	1.0~60.0	5.0	×	×	0907

Function code	Name of parameter	Set Range	Factory	Basic menu	Change	Mailing address
P4.08	Overload forecasting warning detection settings	units' digit: Overload warning detection settings 0: no detect 1: Has been testing 2: Only constant speed detection ten's digit: underload early warning detection Settings 0: no detect 1: Has been testing 2: Only constant speed detection hundred's digit: alarm select 0: Underload were warning, continue to run 1: Underload warning continues to run, overload protection and free parking 2: Overload alarms continues to run, underload protection and free parking 3: Underload fault protection actions and free parking Thousand's digit: Check out the amount of choice 0: Relative to the motor rated current 1: Relative frequency converter rated current	0x0000	×	×	0908
P4.09	Overload forecasting warning detection levels	P4.11(off load detection levels)~200.0	130.0	×	×	0909
P4.10	Overload forecasting warning detection time	1.0~60.0	5.0	×	×	090A
P4.11	Off load detection levels	0.0~P4.09(Overload detection levels)	30.0	×	×	090B
P4.12	Off load detection time	1.0~60.0	5.0	×	×	090C
P4.13	Output current limit alarm detection time	0.0~120.0	5.0	×	×	090D
P4.14	Output current limiting fault detection duration	0.0~600.0	60.0	×	×	090E
P5 Digital quantity function parameters						
P5.00	Terminal status effectively	Bit0~Bit4:X1~X5 0: positive logic 1: negative logic	0x00	×	○	0A00
P5.01	Terminal start protection option	0~1	1	×	×	0A01
P5.02	X1 terminal function	0: No function	6	√	×	0A02

Function code	Name of parameter	Set Range	Factory	Basic menu	Change	Mailing address
P5.03	X2 terminal function	1: Three-line control	7	√	×	0A03
P5.04	X3 terminal function	2: Command to switch to the keyboard	17	√	×	0A04
P5.05	X4 terminal function	3: Command to switch to the terminals				
		4: Command to switch to the Modbus				
		5: Reserve	18	×	×	0A05
		6: Forward RUN (FWD)				
		7: Reverse RUN (REV)				
		8: Forward JOG				
		9: Reverse JOG				
		10: External downtime (press down way down)				
		11: Free parking outside				
		12: External reset input				
		13: Running is prohibited				
		14: The frequency set A switch to B				
		15: Switch to A frequency set combination				
		16: Switch to B frequency set combination				
		17: frequency UP				
		18: frequency DOWN				
		19: Auxiliary setting frequency reset				
		20:Acceleration/deceleration channel selection1				
		21: Acceleration/deceleration channel selection 2				
P5.06	X5 terminal function	22: Acceleration/Deceleration prohibited	12	×	×	0A06
		23: Reserve				
		24: starting DC braking				
		25: stop DC braking				
		26: Multistage speed terminal 1				
		27: Multistage speed terminal 2				
		28: Multistage speed terminal 3				
		29:Reserve				
		30:Multistage speed suspend				
		31:Reserve				
		32: PLC stop memory clear				
		33:PLC run to suspend				
		34:PID closed-loop control to suspend				
		35:PID integral control suspend				
		36:PID positive and negative action				
		37:Reserve				
		38:Multistage closed-loop 1				
		39: Multistage closed-loop 2				

Function code	Name of parameter	Set Range	Factory	Basic menu	Change	Mailing address
		40: Multistage closed-loop 3 41: Reserve 42: Pendulum frequency suspended 43: Pendulum frequency state reset 44~45: Reserve 46: External fault input 47: External interrupt input 48: Reserve 49: Counter input (<200Hz) 50: Counter keep 51: Counter clear 52: Reserve 53: Frequency point move 54: emergency shut down 55: Reserve 56: Running time suspended 57: Running time reset 58~63: Reserve				
P5.07	Terminal start-stop mode selection	0: Two-line mode 1 1: Two-line mode 2 2: Three-line mode 1 3: Three-line mode 2	0	×	×	0A07
P5.08	Increasing frequency UP terminal velocity	0.01~50.00	1.00	×	○	0A08
P5.09	Frequency decline DOWN terminal velocity	0.01~50.00	1.00	×	○	0A09
P5.10	Preset count value given	1~P5.11(To count the given)	1	×	×	0A0A
P5.11	To count the given	P5.10(Preset count value given)~60000	10	×	×	0A0B
P5.12	Terminal count preassigned frequency	1~65535	1	×	×	0A0C
P5.13	Terminal count configuration	units' digit: Count the input terminals 0: Count the input is not action 1: Ordinary terminal (X1 ~ X5), Maximum input frequency is not more than 200 Hz 2: Reserve ten's digit: trigger edge (Common terminal as input available at the time) 0: Rising along the effective 1: Falling edge effectively 2:Up and down along the are effective hundred's digit: Stop counting reset option 0:Stop count value reduction	0x0000	×	×	0A0D

Function code	Name of parameter	Set Range	Factory	Basic menu	Change	Mailing address
		1: Stop continue to count Thousand's digit: Terminal count reaches the action 0: No action 1: Produce halt command 2: Reset the count 3: Reset the count value and generate stop command				
P5.14	Virtual terminal input status	Virtual terminal input selection Bit0~Bit4:X1~X5 0: Virtual terminal is invalid 1: Virtual terminal effective	0x00	×	○	0A0E
P5.15	To detect the delay X1 terminals	0.000~60.000	0.010	×	○	0A0F
P5.16	To detect the delay X2 terminals	0.000~60.000	0.010	×	○	0A10
P5.17	To detect the delay X3 terminals	0.000~60.000	0.010	×	○	0A11
P5.18	To detect the delay X4 terminals	0.000~60.000	0.010	×	○	0A12
P5.19	To detect the delay X5 terminals	0.000~60.000	0.010	×	○	0A13
P5.20	X1 terminal is invalid to detect the latency	0.000~60.000	0.010	×	○	0A14
P5.21	X2 terminal is invalid to detect the latency	0.000~60.000	0.010	×	○	0A15
P5.22	X3 terminal is invalid to detect the latency	0.000~60.000	0.010	×	○	0A16
P5.23	X4 terminal is invalid to detect the latency	0.000~60.000	0.010	×	○	0A17
P5.24	X5 terminal is invalid to detect the latency	0.000~60.000	0.010	×	○	0A18
P5.25	Output terminal set effective operation	Bit0~Bit1:Y、R relay 0: positive logic 1: negative logic	0	×	○	0A19
P5.26	Y output terminals function selection	0:Inverter running signal 1:motor positive and negative transfer instructions 2: Frequency to signal 3: Frequency detection signal level 1(FDT1) 4: Frequency detection signal level 1(FDT2) 5: Reserve	0	√	○	0A1A
P5.27	R Relay function	6:Frequency up limit	15	×	○	0A1B

Function code	Name of parameter	Set Range	Factory	Basic menu	Change	Mailing address
	selection	7: Frequency down limit 8: Overload warning detection 9: Underload early warning detection 10: Current limit alarm output 11: Customize the alarm output 12: undervoltage in the block 13: External downtime 14: Inverter alarm 15: Inverter fault 16: Readiness for operation 17: Simple PLC stages 18: Simple PLC cycle is complete 19: Terminal preset count value 20: Arrive terminal count value 21:Modbus/MXLink control action 22:Reserve 23: Closed-loop detection 24:Closed-loop feedback low detection threshold detection 25:Closed-loop feedback check out high threshold detection 26: AO1 simulation check out the action 27: Timing arrive downtime 28: Run time presets to arrive 29~31: Reserve				
P5.28	Frequency to check out the width	0.00~400.00	2.50	×	○	0A1C
P5.29	FDT1 level upper bound	P5.30(FDT1 level lower bound)~400.00	50.00	×	○	0A1D
P5.30	FDT1 level lower bound	0.00~P5.29(FDT1 level upper bound)	49.00	×	○	0A1E
P5.31	FDT2 level upper bound	P5.32(FDT2 level upper bound)~400.00	25.00	×	○	0A1F
P5.32	FDT2 level lower bound	0.00~P5.31(FDT2 level lower bound)	24.00	×	○	0A20
P5.33	Low value of analog check out the action	0.0 ~ P5.34(High value of simulation check out actions)	20.0	×	○	0A21
P5.34	High value of simulation check out actions	P5.33(Low value of analog check out the action)~100.0	100.0	×	○	0A22
P5.35	Custom alarm output alarm code	0~14	0	×	○	0A23
P5.36~	Reserve					

Function code	Name of parameter	Set Range	Factory	Basic menu	Change	Mailing address
P5.38						
P5.39	Y output terminals close time delay	0.000~60.000	0.000	×	○	0A27
P5.40	R closed relay time delay	0.000~60.000	0.005	×	○	0A28
P5.41	Y output terminals shut off time delay	0.000~60.000	0.000	×	○	0A29
P5.42	R relay shut off time delay	0.000~60.000	0.005	×	○	0A30
P6 Analog function parameters						
P6.00	AI minimum input	0.00~P6.02	0.00	×	○	0C00
P6.01	Corresponding setting of AI minimum input	-100.0%~100.0%	0.0	×	○	0C01
P6.02	AI1 maximum input	P6.00~10.00	10.00	×	○	0C02
P6.03	Corresponding setting of AI maximum input	-100.0%~100.0%	100.0	×	○	0C03
P6.04	AI1 filter time	0.001~9.999	0.010	×	○	0C04
P6.05	Panel potentiometer minimum input	0.00~P6.07	0.00	×	○	0C05
P6.06	Panel potentiometer minimum input values of the corresponding machine	-100.0%~100.0%	0.0	×	○	0C06
P6.07	Largest input panel potentiometer	P6.05~10.00	10.00	×	○	0C07
P6.08	Panel potentiometer maximum input values of the corresponding machine	-100.0%~100.0%	100.0	×	○	0C08
P6.09	Panel potentiometer filtering time	0.001~9.999	0.010	×	○	0C09
P6.10	Reserve					
P6.11	AO function to choose	0:Output Frequency (The relative maximum output frequency) 1:Set frequency (he relative maximum output frequency) 2:Output current (Relative double inverter rated current) 3: Output current (Relative to 2 times the motor rated current) 4:Output voltage(Relative to 1.2 times the	0	√	○	0C0B

Function code	Name of parameter	Set Range	Factory	Basic menu	Change	Mailing address
		motor rated voltage 5: Bus voltage (Relative to 800V) 6~9: Reserve 10: Output power (Relative to 2 times the motor rated power) 11: Inverter overload the cumulative value 12: Motor overload accumulative total value 13: Temperature of the inverter (Relative to 100 degrees) 14: The temperature of the rectifier (Relative to 100 degrees) 15:Modbus/MXLink set(0 ~ 100% corresponding to 0~10V) 16: Process of the closed loop of a given (0~100% corresponding to 0~10V) 17:Closed-loop feedback process (0~100% corresponding to 0~10V) 18:The process of close-loop input bias (-100%~100% corresponding to 0~10V) 19:Process the closed-loop output (0 ~ 100% corresponding to 0~10V) 20:Analog input AI(0 ~ 10V corresponding to 0~10V) 21:Keyboard potentiometer AI(0 ~ 10V corresponding to 0~10V) 22:Reserve 23:Adjusted AI(0~100% corresponding to 0~10V) 24:After the adjustment potentiometer keyboard AI(0~100% corresponding to 0~10V) 26: Regular outage time remaining (0~100.0% corresponding to 0~total time) 27~31: Reserve				
P6.12	AO gain	0.0~200.0	100.0	×	○	0C0C
P6.13	AO zero offset	-100.0~100.0	0.0	×	○	0C0D
P6.14	AO prop filter	0.001~9.999	0.010	×	○	0C0E
P6.15	Analog input curve adjustment options	Unit's digit: 0: AI input without curve adjustment 1: AI input curve adjustment Ten's digit:	0x00	×	○	0C0F

Function code	Name of parameter	Set Range	Factory	Basic menu	Change	Mailing address
		0: Analog input panel without adjustment curve 1: Panel analog input curve adjustment				
P6.16	Curve 1 minimum input	0.0~P6.13	0.0	×	○	0C10
P6.17	Corresponding setting of curve 1 minimum input	0.0~100.0	0.0	×	○	0C11
P6.18	Curve 1 inflection point 1 given	P6.11(Curve 1 Minimum given) ~ P6.15(Curve 1 turning point 2 given)	0.0	×	○	0C12
P6.19	Curve 1 inflection point1 corresponding to the actual amount	0.0~100.0	0.0	×	○	0C13
P6.20	AI curve 1 inflexion 2 input	P6.13~P6.17	100.0	×	○	0C14
P6.21	Corresponding setting of AIcurve 1 inflexion 2 input	0.0~100.0	100.0	×	○	0C15
P6.22	AI curve 1 maximum input	P6.15~100.0	100.0	×	○	0C16
P6.23	Corresponding setting of AIcurve 1 maximum input	0.0~100.0	100.0	×	○	0C17
P6.24~ P6.28	Reserve					
P7 Multistage parameters						
P7.00	Multistage frequency 1	0.00~400.00	5.00	×	○	1400
P7.01	Multistage frequency 2	0.00~400.00	10.00	×	○	1401
P7.02	Multistage frequency 3	0.00~400.00	15.00	×	○	1402
P7.03	Multistage frequency 4	0.00~400.00	20.00	×	○	1403
P7.04	Multistage frequency 5	0.00~400.00	25.00	×	○	1404
P7.05	Multistage frequency 6	0.00~400.00	30.00	×	○	1405
P7.06	Multistage frequency 7	0.00~400.00	35.00	×	○	1406
P7.07	Multistage frequency 8	0.00~400.00	40.00	×	○	1407
P7.08	Multistage closed-loop 1	0.00~10.00	1.00	×	○	1408
P7.09	Multistage closed-loop 2	0.00~10.00	2.00	×	○	1409
P7.10	Multistage closed-loop 3	0.00~10.00	3.00	×	○	140A
P7.11	Multistage closed-loop 4	0.00~10.00	4.00	×	○	140B
P7.12	Multistage closed-loop	0.00~10.00	5.00	×	○	140C

Function code	Name of parameter	Set Range	Factory	Basic menu	Change	Mailing address
	5					
P7.13	Multistage closed-loop 6	0.00~10.00	6.00	×	○	140D
P7.14	Multistage closed-loop 7	0.00~10.00	7.00	×	○	140E
P7.15	Multistage closed-loop 8	0.00~10.00	8.00	×	○	140F
P8 simple PLC						
P8.00	Simple PLC running mode	Unit's digit: PLC run mode 0: Single cycle after downtime 1: Keep the final value after single cycle 2: Continuous loop Ten's digit: Stop memory clear 0: Stop clear memory 1: Stop memory retention hundred's digit : Memory store when power supply drop 0: no storage 1: Storage off electric moment stage, the running time	0x000	√	×	1500
P8.01	Phase 1 set	Unit's digit: accelerate and decelerate time to choose 0: accelerate and decelerate time1 1: accelerate and decelerate time 2 2: accelerate and decelerate time 3 3: accelerate and decelerate time 4 Ten's digit: Unit selection phase time 0: s 1: min Hundred's digit: moving direction 0: Forward run 1: Reverse run	0x000	×	○	1501
P8.02	Phase 1 running time	0000.0~6000.0	10.0	×	○	1502
P8.03	Phase 2 set	With P8.01	0x000	×	○	1503
P8.04	Phase 2 running time	0000.0~6000.0	10.0	×	○	1504
P8.05	Phase 3set	With P8.01	0x000	×	○	1505
P8.06	Phase 3 running time	0000.0~6000.0	10.0	×	○	1506
P8.07	Phase 4 set	With P8.01	0x000	×	○	1507
P8.08	Phase 4 running time	0000.0~6000.0	10.0	×	○	1508
P8.09	Phase 5 set	With P8.01	0x000	×	○	1509
P8.10	Phase 5 running time	0000.0~6000.0	10.0	×	○	150A

Function code	Name of parameter	Set Range	Factory	Basic menu	Change	Mailing address
P8.11	Phase 6 set	With P8.01	0x000	×	○	150B
P8.12	Phase 6 running time	0000.0~6000.0	10.0	×	○	150C
P8.13	Phase 7 set	With P8.01	0x000	×	○	150D
P8.14	Phase 7 running time	0000.0~6000.0	10.0	×	○	150E
P8.15	Phase 8 set	With P8.01	0x000	×	○	150F
P8.16	Phase 8 running time	0000.0~6000.0	10.0	×	○	1510
P9 Closed-loop PID process parameters						
P9.00	Given channel selection	0: Digital keyboard (P9.02) 1: Terminal AI 2: Panel potentiometer 3: More closed loop given 4: Modbus/MXLink communication	0	×	○	1600
P9.01	Digital quantity given	0.00~10.00	0.00	×	○	1601
P9.02	Given the change of time	0.01~600.00	0.10	×	○	1602
P9.03	Feedback channel selection	0: AI 1: Modbus/MXLink communication	0	×	○	1603
P9.04	Filtering time coefficient of Feedback channel	0.01~10.00	0.10	×	○	1604
P9.05	Deviation threshold	0.00~20.00	0.10	×	○	1605
P9.06	Proportional gain	0.000~9.999	0.100	×	○	1606
P9.07	Integral time	0.0~600.0	1.0	×	○	1607
P9.08	Derivative time	0.000~9.999	0.000	×	○	1608
P9.09	sampling period	0.01~60.00	0.10	×	○	1609
P9.10	Output filter coefficient	0.00~10.00	0.01	×	○	160A
P9.11	Output upper limit	P9.12(Output lower limit)~100.0	100.0	×	○	160B
P9.12	Output lower limit	-100.0~P9.11(Output upper limit)	0.0	×	○	160C
P9.13	Closed loop control properties	units' digit: Positive and negative features 0- Forward action 1- Reverse action ten's digit: Differential regulation properties 0- Differential regulation on deviation 1- For differential feedback regulation hundred's digit: Integral initial attribute 0- Integral initial value is zero 1- Integral initial values for the closed-loop output initial value Thousands' digit: Keep the output closed-loop bypass 0- Closed-loop bypass when the output is	0x0000	×	×	160D

Function code	Name of parameter	Set Range	Factory	Basic menu	Change	Mailing address
		zero 1- Closed-loop bypass output keep				
P9.14	Exit the detection threshold	0.0~100.0	0.0	×	×	160E
P9.15	Closed-loop detection threshold	0.0~100.0	0.0	×	×	160F
P9.16	Closed-loop detection time	0.0~600.0	0.0	×	×	1610
P9.17	Feedback protections	units' digit: units' digit: 0: Non detection 1: Has been testing 2: Running test, downtime is not detected ten's digit: Low threshold protection detection processing 0: Protection detection alarm, continue to run 1: To protect freedom of fault detection times, downtime hundred's digit: hing threshold protection test 0: Non detection 1: Has been testing 2: Running test, downtime is not detected Thousands' digit: High threshold protection detect processing 0: Protection detection alarm, continue to run 1: To protect freedom of fault detection times downtime	0x0000	×	×	1611
P9.18	Feedback too high value	P9.20(Feedback is too low)~100.0	95.0	×	×	1612
P9.19	Feedback widely out time	0.1~60.0	5.0	×	×	1613
P9.20	Feedback is too low	0.0~P9.18(Feedback is too low)	5.0	×	×	1614
P9.21	Low feedback check out time	0.0~60.0	5.0	×	×	1615
P9.22	Closed-loop output initial value	-100.0~100.0	0.0	×	×	1616
P9.23	Keep time output initial value	0.00~600.00	0.00	×	×	1617
P9.24	Closed loop differential limiter	0.00~100.00	1.00	×	×	1618
PA Pendulum frequency operation parameters						

Function code	Name of parameter	Set Range	Factory	Basic menu	Change	Mailing address
PA.00	Frequency feature selection	0: ban 1: enabled	0	√	○	1700
PA.01	Swing control	0: Relative center frequency 1: Relative maximum frequency	0	×	○	1701
PA.02	Pendulum frequency range	0.00~50.00	10.00	×	○	1702
PA.03	Jump frequency amplitude	0.00~50.00	10.00	×	○	1703
PA.04	Swing frequency cycle	0.1~1000.0	20.0	×	○	1704
PA.05	Triangle wave rise time	0.0~100.0	50.0	×	○	1705
PA.06~ PA.07	Reserve					
Pb Condition monitoring parameters						
Pb.00	output frequency	0.00~400.00	0.00	×	*	1E00
Pb.01	output frequency (Including slip compensation)	0.00~400.00	0.00	×	*	1E01
Pb.02	set frequency	0.00~400.00	0.00	×	*	1E02
Pb.03	Output current	0.0~3*Ib	0.0	×	*	1E03
Pb.04	Output Voltage	0~Pd.17	0	×	*	1E04
Pb.05	busbar voltage	0~1000	0	×	*	1E05
Pb.06	Reserve					1E06
Pb.07	Output power	-300.0~300.0	0.0	×	*	1E07
Pb.08	Motor running speed	0.00~60000	0.00	×	*	1E08
Pb.09	Load line speed	0.00~600.00	0.00	×	*	1E09
Pb.10	Motor power factor	-1.000~1.000	0.000	×	*	1E0A
Pb.11	Switch status	Bit4~Bit0:X1~X5 Bit7~Bit5: Reserve Bit9~Bit8:Y、R relay status Bit15~Bit10: Reserve	0x0000	√	*	1E0B
Pb.12	terminal count value	00000~65535	0	×	*	1E0C
Pb.13	Reserve					1E0D
Pb.14	AI input	0.00~10.00	0.00	√	*	1E0E
Pb.15	Panel analog	0.00~10.00	0.00	×	*	1E0F
Pb.16	Reserve					
Pb.17	AI curve adjustment	-100.00~100.00	0.00	×	*	1E11
Pb.18	Panel analog curve adjustment	-100.00~100.00	0.00	×	*	1E12
Pb.19	Reserve					

Function code	Name of parameter	Set Range	Factory	Basic menu	Change	Mailing address
Pb.20	Inverter running state 1	Inverter running state 1 Bit0: running state 0:stop 1:run Bit1: moving direction 0: Forward 1: Reverse Bit3~Bit2: Running state 00:Stop 01:Acceleration 10:Deceleration 11:Constant speed Bit5~Bit4:Command channel 00:Keyboard 01:Terml 10:Modbus/MXLink 11:ExBus Bit6: Inverter standby mode 0: Readiness for operation 1: Run ready Bit7: Running state of suspended 0:Unpause 1:Run to suspend Bit15~Bit8: Fehlernummer 0: No fault Other: fault	0x0000	×	*	1E14
Pb.21	Inverter running state 2	Inverter running state 2 Bit0:Simple PLC control effectively 0:Invalid 1:Valid Bit1: PID process control is effective 0: Invalid 1: Valid Bit2: Terminal period of speed control more effectively 0: Invalid 1:Valid Bit3: Ordinary frequency given effective 0: Invalid 1: Valid Bit4: Frequency run effectively 0: Invalid 1: Valid	0x0000	×	*	1E15

Function code	Name of parameter	Set Range	Factory	Basic menu	Change	Mailing address
		Bit5: Tuned to run effectively 0: Invalid 1: Valid Bit6: Inching operation effectively 0: Invalid 1: Valid Bit15~Bit7: Reserve				
Pb.22	Alarm status	Alarm status 0: No alarm status Other: the alarm code	0	×	*	1E16
Pb.23	AO1 output	0.00~10.00	0.00	×	*	1E17
Pb.24~ Pb.29						
Pb.30	Process state of closed-loop control	0x0000~0xFFFF	0x0000	×	*	1E1E
Pb.31	Process closed-loop given	0.0~100.0	0.0	×	*	1E1F
Pb.32	Process closed-loop feedback	0.0~100.0	0.0	×	*	1E20
Pb.33	Process closed-loop error	-100.0~100.0	0.0	×	*	1E21
Pb.34	Process the closed-loop output	-100.0~100.0	0.0	×	*	1E22
Pb.35	Modbus frame reception counter	0~65535	0	×	*	1E23
Pb.36	Modbus effective frame reception counter	0~65535	0	×	*	1E24
Pb.37	Auxiliary frequency	0.00~400.00	0.00	×	*	1E25
Pb.38	Simple PLC operation stage	1~8	1	×	*	1E26
Pb.39~ Pb.49	Reserve					
Pb.50	Motor overload accumulative total value	0.0~100.0	0.0	×	*	1E32
Pb.51	Inverter overload the cumulative value	0.0~100.0	0.0	×	*	1E33
Pb.52	The motor power consumption low	0~10000	0	×	*	1E34
Pb.53	The motor power consumption high	0~65535	0	×	*	1E35
Pb.54	Rectifier side	0.0~100.0	0.0	×	*	1E36

Function code	Name of parameter	Set Range	Factory	Basic menu	Change	Mailing address
	temperature					
Pb.55	Inverter side temperature	0.0~100.0	0.0	√	*	1E37
Pb.56	Conduction time	0~65535	0	×	*	1E38
Pb.57	Run time	0~65535	0	×	*	1E39
Pb.58	Fan running time	0~65535	0	×	*	1E40
Pb.59	Regularly run time remaining	0.0~6500.0	0.0	×	*	1E41
Pb.60 ~Pb.65	Reserve					
PC Fault record parameters						
PC.00	1st fault type	000~039	0	√	*	2200
PC.01	Bus voltage upon 1rd fault	000~1000	0	×	*	2201
PC.02	Current upon 1rd fault	0.0~999.9	0.0	×	*	2202
PC.03	voltage upon 1rd fault	0~380	0	×	*	2203
PC.04	Frequency upon 1rd fault	0.00~400.00	0.00	×	*	2204
PC.05	Output terminal status upon 1rd fault	0x0000~0x0FFF	0x0000	×	*	2205
PC.06	Recently one failure frequency converter running state	Bit0: Running status 0:Stop 1:Run Bit1: Moving direction 0:Reverse 1:Forward Bit3~Bit2:Running state 01:Acceleration 10:Deceleration 11:Constant speed Bit5~Bit4:command channel 00:Keyboard 01:External terminals 10:Modbus/MXLink communication 11: Extend Bit6: Inverter standby mode 0: Readiness for operation 1: Run ready Bit7:Reserve Bit8: Simple PLC control effectively 0:Invalid	0x0000	×	*	2206

Function code	Name of parameter	Set Range	Factory	Basic menu	Change	Mailing address
		1:Valid Bit9: PID process control is effective 0:Invalid 1:Valid Bit10:Terminal period of speed control more effectively 0: Invalid 1: Valid Bit11: Ordinary frequency given effective 0: Invalid 1: Valid Bit12: Frequency control effectively 0: Invalid 1: Valid Bit13:Reserve Bit14: Inching operation effectively 0: Invalid 1: Valid				
PC.07	2st fault type	000~039	0	√	*	2207
PC.08	Bus voltage upon 2rd fault	000~1000	0	×	*	2208
PC.09	Current upon 2rd fault	0.0~999.9	0.0	×	*	2209
PC.10	voltage upon 2rd fault	0~380	0	×	*	220A
PC.11	Frequency upon 2rd fault	0.00~400.00	0.00	×	*	220B
PC.12	Output terminal status upon 2rd fault	0x0000~0x0FFF	0x0000	×	*	220C
PC.13	Second from bottom of failure frequency converter running state	0x0000~0xFFFF	0x0000	×	*	220D
PC.14	3st fault type	000~039	0	√	*	220E
PC.15	Bus voltage upon 3rd fault	000~1000	0	×	*	220F
PC.16	Current upon 3rd fault	0.0~999.9	0.0	×	*	2210
PC.17	voltage upon 3rd fault	0~380	0	×	*	2211
PC.18	Frequency upon 3rd fault	0.00~400.00	0.00	×	*	2212
PC.19	The third time of failure digital terminal state	0x0000~0x0FFF	0x0000	×	*	2213
PC.20	The third time failure frequency converter	0x0000~0xFFFF	0x0000	×	*	2214

Function code	Name of parameter	Set Range	Factory	Basic menu	Change	Mailing address
	running state					
Pd System configuration parameters						
Pd.00	user password	0: No Password Other: password protection	0	√	○	3200
Pd.01	list view	0: Basic menu mode 1: Advanced menu mode 2: factory value comparison mode	1	√	○	3201
Pd.02	Parameters to protect	0: Besides the function code all the parameters from modification 1: Besides the function code and P00.00, modification is prohibited 2: All parameters are allowed to change	2	√	×	3202
Pd.03	keyboard Settings	units' digit: Reserve ten's digit: STOP double-click function 0: non-function 1: Free parking(All commands channel) hundred's digit: STOP key feature selection 0: No keyboard control method is invalid 1: No keyboard control mode in down way down 2: No keyboard control way free downtime Thousands' digit: Key lock function 0: latch up free 1: lock 2: except RUN、STOP Key lock all 3: except SHIFT Key lock all	0x0000	×	○	3203
Pd.04	Reserve					
Pd.05	Braking energy function	0: Forbid 1: Enable	0	×	×	3205
Pd.06	Braking action voltage	The brake unit action voltage value 220V: 370~390 380V: 650~750	380(220) 720(380)	×	○	3206
Pd.07	Braking energy usage	0.0~100.0	10.0	×	○	3207
Pd.08	Fan operation control	0: Electricity has been running 1: Inverter operation is running 2: According to the machine temperature automatic control	1	×	○	3208
Pd.09	Stop display preferences	Binary set: 0- Not Displayed 1- display units' digit: Bit0: set frequency (Hz) Bit1: Reserve Bit2: Bus voltage (V)	0x0005	×	○	3209

Function code	Name of parameter	Set Range	Factory	Basic menu	Change	Mailing address
		Bit3:Terminal state (/) ten's digit: Bit0:AI(V) Bit1: Panel potentiometer (V) Bit2:Reserve Bit3:Reserve hundred's digit: Bit0: Close Loop Correction (%) Bit1:Closed loop setting (%) Bit2: Terminal count (/) Bit3: PLC run phase (/) thousands' digit: keep				
Pd.10	According to parameter selection 1	Binary set: 0- Not Displayed 1- display units' digit: Bit0: output frequency (Hz) Bit1: set frequency(Hz) Bit2: output current (A) Bit3: output voltage (V) ten's digit: Bit0: busbar voltage (V) Bit1: output power (%) Bit2:Reserve Bit3: Output power factor (/) hundred's digit: Bit0:Reserve Bit1:AI(V) Bit2: Panel potentiometer (V) Bit3:Reserve thousands' digit: Bit0:AI Internal percentile, the curve adjustments (%) Bit1: Panel potentiometer, internal percentile curves adjustment (%) Bit2: Reserve Bit3: Reserve	0x0017	×	○	320A
Pd.11	According to parameter selection 2	Binary set: 0- Not Displayed 1- display units' digit: Bit0: Terminal state (/) Bit1: Terminal count (/) Bit2: Reserve Bit3:PLC run phase (/) ten's digit: Bit0:Closed loop feedback (%)	0x0000	×	○	320B

Function code	Name of parameter	Set Range	Factory	Basic menu	Change	Mailing address
		Bit1: Closed loop setting (%) Bit2: Closed loop error (%) Bit3: Closed-loop output (%) hundred's digit: Bit0: Cumulative inverter overloading (%) Bit1: Motor overload the cumulative (%) Bit2: Temperature of the inverter (°C) Bit3: Reserve Thousands' digit: Bit0: Running RPM (rpm) Bit1: Line speed (m/s) Bit2: Reserve Bit3: Reserve				
Pd.12	Product code	1~999	100	×	*	320C
Pd.13	Control panel software version number	1.00~9.99	1.03	×	*	320D
Pd.14	Control panel software version number	0x0000~0xFFFF	0x0000	×	*	320E
Pd.15	Reserve					
Pd.16	Inverter rated capacity	0.0~999.9	Factory set up	×	*	3210
Pd.17	Inverter rated voltage	0~1000		×	*	3211
Pd.18	Inverter rated current	0~1000.0		×	*	3212
Pd.19	Reserve					
Pd.20	Parameters to restore the backup Settings	0: failure to actuate 1~10: Reserve 11: Restore basic menu parameters 12~21: Reserve 22: Restore advanced menu parameters 23: Reserve 24: Restore advanced menu parameters (excluding motor) 25: Reserve 26: Restore factory value mapping parameters 27~43: Reserve 44: Eliminate malfunction records 45~54: Reserve 55: Parameters of the backup 56~65: Reserve 66: recover from a backup area parameters 67~99: Reserve	0	×	×	3214
PU Communications parameters						

Function code	Name of parameter	Set Range	Factory	Basic menu	Change	Mailing address
PU.00	Communication configuration	units' digit: Baud rate choice 0:4800 BPS 1:9600 BPS 2:19200 BPS 3:38400 BPS 4:57600 BPS 5:115200 BPS ten's digit: Data Format 0:1-8-2-N,RTU 1:1-8-1-E,RTU 2:1-8-1-O,RTU hundred's digit: communication protocol 0:Modbus 1:MXLink	0x001	√	×	3400
PU.01	machine address	0~247	6	×	×	3401
PU.02	Communication timeout detection time	0.0~6000.0	0.0	×	×	3402
PU.03	The machine response delay	0~1000	5	×	×	3403
PU.04	Frequency ratio	0.00~99.99	1.00	×	×	3404
PU.05	Communication parameters protection option	units' digit:Communication control parameters (0x3BXX) If protected by a user's password units' digit: Communication control parameters (0 x3bxx) user password protection Settings 0: forbid 1: Enabled ten's digit: user to save parameters (Pn) If protected by a user's password 0: Communication access Pn parameters, speaking, reading and writing is not protected by the user password 1: Communication access Pn parameters write protected by the user password, read from the password protection 2: Communication is protected by the user password access Pn parameters, speaking, reading and writing hundred's digit: The user to save parameters Pn group Hidden Settings: 0: display 1:Hidden	0x0000	×	×	3405

Function code	Name of parameter	Set Range	Factory	Basic menu	Change	Mailing address
		Thousand's digit: Address mapping parameters Ph group hidden set 0: display 1: Hidden				
PU.06	Communication parameters save option	units' digit : Write command to save option 0:0x06,0x10,0x12, 0x17 Power-down no save 1:0x06 for power save,0x10,0x12, 0x17 Save for power 2:0x06,0x10,0x12, 0x17 to power save command ten's place: The user to save parameters Pn save option 0: Be bound by communication write command is saved 1:Not be bound by communication write command to save, write command is stored hundred, thousand: reservations	0x00	○	×	3406
PU.07	Reserve					
Pn The user to save parameters						
Pn.00	Saving parameters 1	0~65535	0	×	×	3900
Pn.01	Saving parameters 2	0~65535	0	×	×	3901
Pn.02	Saving parameters3	0~65535	0	×	×	3902
Pn.03	Saving parameters4	0~65535	0	×	×	3903
Pn.04	Saving parameters5	0~65535	0	×	×	3904
Pn.05	Saving parameters6	0~65535	0	×	×	3905
Pn.06	Saving parameters7	0~65535	0	×	×	3906
Pn.07	Saving parameters8	0~65535	0	×	×	3907
Pn.08	Saving parameters9	0~65535	0	×	×	3908
Pn.09	Saving parameters10	0~65535	0	×	×	3909
Pn.10	Saving parameters11	0~65535	0	×	×	390A
Pn.11	Saving parameters12	0~65535	0	×	×	390B
Pn.12	Saving parameters13	0~65535	0	×	×	390C
Pn.13	Saving parameters14	0~65535	0	×	×	390D
Pn.14	Saving parameters15	0~65535	0	×	×	390E
Pn.15	Saving parameters16	0~65535	0	×	×	390F
Pn.16	Saving parameters17	0~65535	0	×	×	3910
Pn.17	Saving parameters18	0~65535	0	×	×	3911

Function code	Name of parameter	Set Range	Factory	Basic menu	Change	Mailing address
Pn.18	Saving parameters19	0~65535	0	×	×	3912
Pn.19	Saving parameters20	0~65535	0	×	×	3913
Pn.20	Saving parameters21	0~65535	0	×	×	3914
Pn.21	Saving parameters22	0~65535	0	×	×	3915
Pn.22	Saving parameters23	0~65535	0	×	×	3916
Pn.23	Saving parameters24	0~65535	0	×	×	3917
Pn.24	Saving parameters25	0~65535	0	×	×	3918
Pn.25	Saving parameters26	0~65535	0	×	×	3919
Pn.26	Saving parameters27	0~65535	0	×	×	391A
Pn.27	Saving parameters28	0~65535	0	×	×	391B
Pn.28	Saving parameters29	0~65535	0	×	×	391C
Pn.29	Saving parameters30	0~65535	0	×	×	391D
Pn.30	Saving parameters31	0~65535	0	×	×	391E
Pn.31	Saving parameters32	0~65535	0	×	×	391F
Pn.32	Saving parameters33	0~65535	0	×	×	3920
Pn.33	Saving parameters34	0~65535	0	×	×	3921
Pn.34	Saving parameters35	0~65535	0	×	×	3922
Pn.35	Saving parameters36	0~65535	0	×	×	3923
Pn.36	Saving parameters37	0~65535	0	×	×	3924
Pn.37	Saving parameters38	0~65535	0	×	×	3925
Pn.38	Saving parameters39	0~65535	0	×	×	3926
Pn.39	Saving parameters40	0~65535	0	×	×	3927
Pn.40	Saving parameters41	0~65535	0	×	×	3928
Pn.41	Saving parameters42	0~65535	0	×	×	3929
Pn.42	Saving parameters43	0~65535	0	×	×	392A
Pn.43	Saving parameters44	0~65535	0	×	×	392B
Pn.44	Saving parameters45	0~65535	0	×	×	392C
Pn.45	Saving parameters46	0~65535	0	×	×	392D
Pn.46	Saving parameters47	0~65535	0	×	×	392E
Pn.47	Saving parameters48	0~65535	0	×	×	392F
Pn.48	Saving parameters49	0~65535	0	×	×	3930
Pn.49	Saving parameters50	0~65535	0	×	×	3931
Pn.50	Saving parameters51	0~65535	0	×	×	3932
Pn.51	Saving parameters52	0~65535	0	×	×	3933
Pn.52	Saving parameters53	0~65535	0	×	×	3934
Pn.53	Saving parameters54	0~65535	0	×	×	3935
Pn.54	Saving parameters55	0~65535	0	×	×	3936
Pn.55	Saving parameters56	0~65535	0	×	×	3937

Function code	Name of parameter	Set Range	Factory	Basic menu	Change	Mailing address
Pn.56	Saving parameters57	0~65535	0	×	×	3938
Pn.57	Saving parameters58	0~65535	0	×	×	3939
Pn.58	Saving parameters59	0~65535	0	×	×	393A
Pn.59	Saving parameters60	0~65535	0	×	×	393B
Pn.60	Saving parameters61	0~65535	0	×	×	393C
Pn.61	Saving parameters62	0~65535	0	×	×	393D
Pn.62	Saving parameters63	0~65535	0	×	×	393E
Pn.63	Saving parameters64	0~65535	0	×	×	393F
Ph Communications parameters						
Ph.00	Address mapping make	0: forbide 1: enable	0	×	×	3A00
Ph.01	Mapping address 1	0x0000~0xFFFF	0x0000	×	×	3A01
Ph.02	Argument addresses 1	0x0000~0xFFFF	0x0000	×	×	3A02
Ph.03	Mapping address 2	0x0000~0xFFFF	0x0000	×	×	3A03
Ph.04	Argument addresses 2	0x0000~0xFFFF	0x0000	×	×	3A04
Ph.05	Mapping address 3	0x0000~0xFFFF	0x0000	×	×	3A05
Ph.06	Argument addresses 3	0x0000~0xFFFF	0x0000	×	×	3A06
Ph.07	Mapping address 4	0x0000~0xFFFF	0x0000	×	×	3A07
Ph.08	Argument addresses 4	0x0000~0xFFFF	0x0000	×	×	3A08
Ph.09	Mapping address 5	0x0000~0xFFFF	0x0000	×	×	3A09
Ph.10	Argument addresses 5	0x0000~0xFFFF	0x0000	×	×	3A0A
Ph.11	Mapping address 6	0x0000~0xFFFF	0x0000	×	×	3A0B
Ph.12	Argument addresses 6	0x0000~0xFFFF	0x0000	×	×	3A0C
Ph.13	Mapping address 7	0x0000~0xFFFF	0x0000	×	×	3A0D
Ph.14	Argument addresses 7	0x0000~0xFFFF	0x0000	×	×	3A0E
Ph.15	Mapping address 8	0x0000~0xFFFF	0x0000	×	×	3A0F
Ph.16	Argument addresses 8	0x0000~0xFFFF	0x0000	×	×	3A10
Ph.17	Mapping address 9	0x0000~0xFFFF	0x0000	×	×	3A11
Ph.18	Argument addresses 9	0x0000~0xFFFF	0x0000	×	×	3A12
Ph.19	Mapping address10	0x0000~0xFFFF	0x0000	×	×	3A13
Ph.20	Argument addresses 10	0x0000~0xFFFF	0x0000	×	×	3A14
Ph.21	Mapping address 11	0x0000~0xFFFF	0x0000	×	×	3A15
Ph.22	Argument addresses 11	0x0000~0xFFFF	0x0000	×	×	3A16
Ph.23	Mapping address 12	0x0000~0xFFFF	0x0000	×	×	3A17
Ph.24	Argument addresses 12	0x0000~0xFFFF	0x0000	×	×	3A18
Ph.25	Mapping address 13	0x0000~0xFFFF	0x0000	×	×	3A19









Function code	Name of parameter	Set Range	Factory	Basic menu	Change	Mailing address
Ph.26	Argument addresses 13	0x0000~0xFFFF	0x0000	×	×	3A1A
Ph.27	Mapping address 14	0x0000~0xFFFF	0x0000	×	×	3A1B
Ph.28	Argument addresses 14	0x0000~0xFFFF	0x0000	×	×	3A1C
Ph.29	Mapping address 15	0x0000~0xFFFF	0x0000	×	×	3A1D
Ph.30	Argument addresses 15	0x0000~0xFFFF	0x0000	×	×	3A1E
Ph.31	Mapping address 16	0x0000~0xFFFF	0x0000	×	×	3A1F
Ph.32	Argument addresses 16	0x0000~0xFFFF	0x0000	×	×	3A20
Ph.33	Mapping address 17	0x0000~0xFFFF	0x0000	×	×	3A21
Ph.34	Argument addresses 17	0x0000~0xFFFF	0x0000	×	×	3A22
Ph.35	Mapping address 18	0x0000~0xFFFF	0x0000	×	×	3A23
Ph.36	Argument addresses 18	0x0000~0xFFFF	0x0000	×	×	3A24
Ph.37	Mapping address 19	0x0000~0xFFFF	0x0000	×	×	3A25
Ph.38	Argument addresses 19	0x0000~0xFFFF	0x0000	×	×	3A26
Ph.39	Mapping address 20	0x0000~0xFFFF	0x0000	×	×	3A27
Ph.40	Argument addresses 20	0x0000~0xFFFF	0x0000	×	×	3A28
Ph.41	Mapping address 21	0x0000~0xFFFF	0x0000	×	×	3A29
Ph.42	Argument addresses 21	0x0000~0xFFFF	0x0000	×	×	3A2A
Ph.43	Mapping address 22	0x0000~0xFFFF	0x0000	×	×	3A2B
Ph.44	Argument addresses 22	0x0000~0xFFFF	0x0000	×	×	3A2C
Ph.45	Mapping address 23	0x0000~0xFFFF	0x0000	×	×	3A2D
Ph.46	Argument addresses 23	0x0000~0xFFFF	0x0000	×	×	3A2E
Ph.47	Mapping address 24	0x0000~0xFFFF	0x0000	×	×	3A2F
Ph.48	Argument addresses 24	0x0000~0xFFFF	0x0000	×	×	3A30
Ph.49	Mapping address 25	0x0000~0xFFFF	0x0000	×	×	3A31
Ph.50	Argument addresses 25	0x0000~0xFFFF	0x0000	×	×	3A32
Ph.51	Mapping address 26	0x0000~0xFFFF	0x0000	×	×	3A33
Ph.52	Argument addresses 26	0x0000~0xFFFF	0x0000	×	×	3A34

Function code	Name of parameter	Set Range	Factory	Basic menu	Change	Mailing address
Ph.53	Mapping address 27	0x0000~0xFFFF	0x0000	×	×	3A35
Ph.54	Argument addresses 27	0x0000~0xFFFF	0x0000	×	×	3A36
Ph.55	Mapping address 28	0x0000~0xFFFF	0x0000	×	×	3A37
Ph.56	Argument addresses 28	0x0000~0xFFFF	0x0000	×	×	3A38
Ph.57	Mapping address 29	0x0000~0xFFFF	0x0000	×	×	3A39
Ph.58	Argument addresses 29	0x0000~0xFFFF	0x0000	×	×	3A3A
Ph.59	Mapping address 30	0x0000~0xFFFF	0x0000	×	×	3A3B
Ph.60	Argument addresses 30	0x0000~0xFFFF	0x0000	×	×	3A3C
Ph.61	Mapping address 31	0x0000~0xFFFF	0x0000	×	×	3A3D
Ph.62	Argument addresses 31	0x0000~0xFFFF	0x0000	×	×	3A3E
Ph.63	Mapping address 32	0x0000~0xFFFF	0x0000	×	×	3A3F
Ph.64	Argument addresses 32	0x0000~0xFFFF	0x0000	×	×	3A40
Ph.65	Internal map address 1	0x0000~0xFFFF	3A41	×	×	3A41
Ph.66	Internal map address 2	0x0000~0xFFFF	3A42	×	×	3A42
Ph.67	Internal map address 3	0x0000~0xFFFF	3A43	×	×	3A43
Ph.68	Internal map address 4	0x0000~0xFFFF	3A44	×	×	3A44
Ph.69	Internal map address 5	0x0000~0xFFFF	3A45	×	×	3A45
Ph.70	Internal map address 6	0x0000~0xFFFF	3A46	×	×	3A46
Ph.71	Internal map address 7	0x0000~0xFFFF	3A47	×	×	3A47
Ph.72	Internal map address 8	0x0000~0xFFFF	3A48	×	×	3A48
Ph.73	Internal map address 9	0x0000~0xFFFF	3A49	×	×	3A49
Ph.74	Internal map address 10	0x0000~0xFFFF	3A4A	×	×	3A4A
Ph.75	Internal map address 11	0x0000~0xFFFF	3A4B	×	×	3A4B
Ph.76	Internal map address 12	0x0000~0xFFFF	3A4C	×	×	3A4C
Ph.77	Internal map address 13	0x0000~0xFFFF	3A4D	×	×	3A4D
Ph.78	Internal map address 14	0x0000~0xFFFF	3A4E	×	×	3A4E
Ph.79	Internal map address	0x0000~0xFFFF	3A4F	×	×	3A4F

Function code	Name of parameter	Set Range	Factory	Basic menu	Change	Mailing address
	15					
Ph.80	Internal map address 16	0x0000~0xFFFF	3A50	×	×	3A50
Ph.81	Internal map address 17	0x0000~0xFFFF	3A51	×	×	3A51
Ph.82	Internal map address 18	0x0000~0xFFFF	3A52	×	×	3A52
Ph.83	Internal map address 19	0x0000~0xFFFF	3A53	×	×	3A53
Ph.84	Internal map address 20	0x0000~0xFFFF	3A54	×	×	3A54
PE Parameter of motor						
PE.00	Rated power	0.4~999.9	1.5	×	×	3C00
PE.01	Rated current	0.1~999.9	7.5	×	×	3C01
PE.02	Rated voltage	60~380	220	×	×	3C02
PE.03	Rated frequency	1.00~400.00	50.00	×	×	3C03
PE.04	Rated speed	1~30000	1440	×	×	3C04
PE.05	Reserve					3C05
PE.06	Unload current	0.1~999.9	3.5	×	×	3C06
PE.07	Stator resistance	0.01~50.00	9.00	×	×	3C07
PE.08~ PE.11	Reserve					
PE.12	Motor overload protection mode selection	0:Failure to actuate 1: General motors 2:Variable frequency motor	1	×	×	3C0C
PE.13	Motor overload protection curve coefficient	10.0~120.0	100.0	×	×	3C0D
PE.14	Reserve					3C0F

Chapter 6 Common symbols display and fault alarm processing methods

6.1 Common display symbols causes and treatment





Display	Name	Possible Causes	Solutions
	Running is prohibited	<ol style="list-style-type: none"> 1. Terminal effective state, the terminal choose 13 - running is prohibited 2. Communications given the run command is prohibited 	<ol style="list-style-type: none"> 1. Run ban function terminal status as invalid 2. Communications given allowed to run command
	Run for	<ol style="list-style-type: none"> 1. Frequency is less than the given start frequency at startup 2. Start frequency is zero 	<ol style="list-style-type: none"> 1. Check frequency size, so that it is greater than or equal to start frequency 2. Check frequency size, so that it is greater than or equal to start frequency
	Run to suspend	<ol style="list-style-type: none"> 1. Terminal chose 47 - external interrupt input function, and terminal state is effective 2. In the nick of time for automatic reset 	<ol style="list-style-type: none"> 1. The external interrupt input function terminal state as invalid 2. The time interval to disappear automatically
	Dc brake	Starting dc brake or stop dc brake	Brake complete disappear automatically
	Key lock effective	Through the key combination on the keyboard lock, During the operation or key lock button operation	Using a combination of keys to unlock
	Key lock is invalid	Through the key combinations of keys to unlock operation	
	The user password authentication	User password protection is valid input user password correctly	
	The user password authentication failed	User password protection is valid user password input error	Input the correct password









6.2 Fault alarm and processing method















There are two kinds of MF series VFD fault type: Fault and alarm. When failure occurs and alarm, Frequency converter according to the customer set us the corresponding code. When the VFD quoted fault code, VFD blockade output, And failure indicator ALM normally on, It is only to press the reset signal, VFD can normal boot, When p code converter report, normal operation of converter, failure indicator ALM flicker. When the VFD to the fault code, the alarm light is normally on.









The following table lists the common fault causes and solutions, so that customers in accordance with this section

suggest checking, analysis the cause of the problem, find out the solution. If the problem cannot be solved, can contact the purchased VFD agents or directly with your company.

The fault		The alarm		The fault types	Possible reasons for failure type	The solution
NO.	code	NO.	code			
01				To accelerate the flow	<ol style="list-style-type: none"> 1. The motor speed too fast 2. The motor speed is too fast 3. Load mutation or abnormal 4. Interphase short circuit or three-phase output To ground short circuit 5. Starting rotation of the motor 6. A manual torque increase is too large 7. V/F curve is not appropriate 8. Motor vector control system parameters are set Setting is not correct 9. The closed-loop vector PG feedback often 10. The grid voltage is too low 11. The VFD power is too small 	<ol style="list-style-type: none"> 1. Increase the acceleration time 2. Increase the acceleration/acceleration/deceleration time 3. Check the load 4. Check the output connection, measuring machine And resistance, the insulation 5. Use dc braking or starting Speed tracking starting rotation of the motor 6. Set the appropriate manual torque Mention of appreciation 7. Set the appropriate V/F of the curve 8. Properly set parameters of motor nameplates Learning and motor parameters 9. Check the PG card connection 10. Check the input power supply 11. Increase the frequency converter capacity
02				Slow flow		
03				Constant speed over current		
04				Accelerate the overvoltage	<ol style="list-style-type: none"> 1. The abnormal input power 2. The instantaneous power, motor to stop Stop rotating to start 	<ol style="list-style-type: none"> 1. Check the input power supply 2. To ensure that the motor after stop running

The fault		The alarm		The fault types	Possible reasons for failure type	The solution
NO.	code	NO.	code			
					again	restart
05				Deceleration overvoltage	<ol style="list-style-type: none"> 1. Abnormal input power 2. Slow down too fast 3. the load inertia 	<ol style="list-style-type: none"> 1. Check the input power 2. Increasing the acceleration/acceleration/deceleration time 3. With proper braking resistor
06				Constant speed over voltage	<ol style="list-style-type: none"> 1. The power input voltage instability 2. The load inertia 	<ol style="list-style-type: none"> 1. Check the input power, the use of pay Input flow reactor 2. Use the appropriate braking resistor
07		09		The VFD overload	<ol style="list-style-type: none"> 1. Power grid voltage is too low 2. Speed is too fast 3. VFD power is too small/motor is too large 4. Moments after the blackout, motor to stop rotating and start again 	<ol style="list-style-type: none"> 1. Check the input power supply 2. Increase the acceleration time 3. Select adapter converter or motor 4. Ensure the stop and start the motor
08		09		Motor overload	<ol style="list-style-type: none"> 1. Power grid voltage is too low 2. The motor rated current setting is not correct 3. Motor blocked or load sudden increase 	<ol style="list-style-type: none"> 1. Check the input power supply 2. Set the motor rated current 3. Check the load and torque increase quantity adjustment
09				inverter overheats	<ol style="list-style-type: none"> 1. The fan is damaged or duct obstruction 2. The environment temperature is too high 3. The carrier frequency set too high 4. Temperature detecting element damage 	<ol style="list-style-type: none"> 1. Replace the fan or clean up the air duct 2. Reduce the environmental temperature 3. Use or lower carrier 4. Contact service or the company
10				整流器过热		

The fault		The alarm		The fault types	Possible reasons for failure type	The solution
NO.	code	NO.	code			
11				The module failure	<ol style="list-style-type: none"> 1. Motor phase fault 2. The abnormal load change 	<ol style="list-style-type: none"> 1. Check the motor wiring 2. Check the load
12		01		Input phase loss	<ol style="list-style-type: none"> 1. The input power supply R, S and T phase 2. Input power serious imbalance 	<ol style="list-style-type: none"> 1. Check the input wiring 2. Check the input power supply
13		02		Output phase loss	<ol style="list-style-type: none"> 1. There are a lack of output U, V, W 2. The driver board 	<ol style="list-style-type: none"> 1. Check the wiring installation 2. Contact service or our company
14				External fault	<ol style="list-style-type: none"> 1. Through the terminal input the external fault signal effectively 	<ol style="list-style-type: none"> 1. External reset the fault after fault clearance
15		06		Process of the closed loop feedback is too low	<ol style="list-style-type: none"> 1. The feedback is broken 2. Low feedback detection parameter Settings 	<ol style="list-style-type: none"> 1. Testing whether feedback line break 2. Reset the feedback loss protection parameters
16		07		Process of the closed loop feedback is too high	<ol style="list-style-type: none"> 1. Process of closed loop of a given line disconnect 2. Simulation to timing, given value is too small 	<ol style="list-style-type: none"> 1. Detection of closed loop whether a given line break 2. Check whether simulation given within the range
20		08		underload	<ol style="list-style-type: none"> 1. Abnormal load 2. Motor parameter setting is not correct 3. Off load detection level is too big 	<ol style="list-style-type: none"> 1. Check the load 2. Reset the motor parameters 3. Reduced load detection levels
27				The ADC reference a given fault	<ol style="list-style-type: none"> 1. Hardware for a given circuit fault 2. Software failure 	<ol style="list-style-type: none"> Contact service or the company
28				Current sampling circuit malfunction	<ol style="list-style-type: none"> 1. Control panel loose connection or plug-in 2. Auxiliary power supply damage 3. Damage of the signal processing circuit 	<ol style="list-style-type: none"> 1. Check and reinstall the terminal 2. Contact service or the company 3. Contact service or the company

The fault		The alarm		The fault types	Possible reasons for failure type	The solution
NO.	code	NO.	code			
29				Contact service or the company	<ol style="list-style-type: none"> 1.Serious external interference 2.The CPU to read and write error 	<ol style="list-style-type: none"> 1.Press the STOP/RESET button RESET or plus the power filter in power input side 2.Press the STOP/RESET button RESET or contact the service provider or the company
30		04		485 communication failures	<ol style="list-style-type: none"> 1.A serial port communication parameter Settings do not match 2. Wiring fault 3.Carrier frequency is set too high 	<ol style="list-style-type: none"> 1.To set the correct parameters of serial communication 2.Check 485 line connection 3. Reduce the carrier frequency
32		03		EEPROM fault	<ol style="list-style-type: none"> 1.The control parameters of the error, speaking, reading and writing 2.The EEPROM is damaged 	<ol style="list-style-type: none"> 1. Press the STOP/RESET button RESET Contact service or the company 2. Contact service or our company
33				Parameters copy fault	<ol style="list-style-type: none"> 1.Block operation panel EEPROM problems 2.The VFD parameters to the operation panel data errors 3.Operation panel version number is not correct 	<ol style="list-style-type: none"> 1.Contact service or the company 2.Check the operation panel connections 3.Contact service or the company
36				Keyboard communication failures	<ol style="list-style-type: none"> 1.Operation panel communication break line 	<ol style="list-style-type: none"> 1.Check the operation panel with the host of the telecommunication lines
37				Softwar supercurrent	<ol style="list-style-type: none"> 1.Acceleration/acceleration/deceleration time is too short 2. The current detection circuit fault 3. Start the rotation of the motor 	<ol style="list-style-type: none"> 1.Extend the acceleration/acceleration/deceleration time 2.Contact service or the company 3.Motor stationary before you start

The fault		The alarm		The fault types	Possible reasons for failure type	The solution
NO.	code	NO.	code			
38				The module failure	The reference module failure	The reference module failure
40		10		The fault current limiting continued	<ol style="list-style-type: none"> 1. Motor acceleration/acceleration/deceleration too fast 2. The power grid voltage is too low 3. The VFD power is too small 4. Load inertia torque too large 	<ol style="list-style-type: none"> 1. Increase the acceleration time 2. Check the input power or power grid voltage 3. Replace the high power inverter
41				undervoltage	<ol style="list-style-type: none"> 1. Power grid voltage is too low 	<ol style="list-style-type: none"> 1. Check the input power or power grid voltage
42				U phase module to protect	<ol style="list-style-type: none"> 1. Motor phase fault 2. The VFD output to ground short circuit 	<ol style="list-style-type: none"> 1. Check the motor wiring 2. Check the motor insulation 3. Prolonged acceleration/acceleration/deceleration time 4. Check the load 5. Contact the manufacturer
43				V phase module to protect	<ol style="list-style-type: none"> 3. The acceleration/acceleration/deceleration time Settings are too short 	
44				W phase module to protect	<ol style="list-style-type: none"> 4. Abnormal load change 5. Serious interference 	
45				Inverter modules detect abnormal temperature	<ol style="list-style-type: none"> 1. Temperature detecting element is broken 2. Beyond the range temperature detection 	<ol style="list-style-type: none"> 1. Check the temperature detecting element connection 2. Check the temperature detecting element connection 3. Change the temperature detecting element
46				Rectifier module detect abnormal temperature	<ol style="list-style-type: none"> 3. Temperature detecting element failure 	

Note

- ◆ Please carefully chosen fault alarm function, otherwise may cause accident expanded, personal injury and property damage to property.

6.3 Common fault alarm and processing methods

No.	Common phenomenon	Possible reasons for	The solution
1	There is no display at power-on	<ol style="list-style-type: none"> 1. No or low voltage power grid 2. The inverter drive switch power supply is faulty 3. Rectifier bridge damage 4. Control board and drive board, keyboard ribbon cable fault 5. Control panel or the keyboard failure 	<ol style="list-style-type: none"> 1. Check the power supply. 2. Check the bus voltage 3. Check the control board and drive board, keyboard ribbon cable 4. Contact the manufacturer
2	Motor does not turn after inverter operation	<ol style="list-style-type: none"> 1. Motor or motor fault line 2. Inverter parameter error 3. The control board and drive board wiring, poor contact 4. Driver board failure 	<ol style="list-style-type: none"> 1. Check motor or motor and frequency converter connection 2. Reset the inverter parameter 3. Test control board and drive board wiring 4. Contact the manufacturer
3	Contact the manufacturer	<ol style="list-style-type: none"> 1. A given unstable frequency 2. A given unstable frequency improper 	<ol style="list-style-type: none"> 1. Inspection frequency for a given channel, set appropriate filter is given 2. Change the inverter related parameters
4	Inverter frequent over-voltage or over-current	<ol style="list-style-type: none"> 1. Inverter input and output wiring anomaly 2. Deceleration parameter setting problem 3. The load fluctuation big 4. Inverter power is too small 	<ol style="list-style-type: none"> 1. Inverter input and output wiring 2. Reset the deceleration parameters 3. Reduce the load of volatility 4. Replace the high level power inverter
5	Frequent current limit on the frequency converter	<ol style="list-style-type: none"> 1. Deceleration motor too fast 2. Power grid voltage is too low 3. Inverter power is too small 4. The load inertia torque 	<ol style="list-style-type: none"> 1. Increase the acceleration time 2. Check the input power or power grid voltage 3. Replace the high level power inverter
6	Inverter to frequent overload	<ol style="list-style-type: none"> 1. Inverter to frequent overload 2. Speed is too fast 3. Inverter power is too small or motor too much 4. Moments after the blackout, motor to stop rotating and start again 	<ol style="list-style-type: none"> 1. Check the input power 2. Increase the acceleration time 3. Choose adapter converter or motor 4. To ensure that the motor stop running after the restart
7	Inverter to frequent overheating	<ol style="list-style-type: none"> 1. Large carrier frequency 2. Stalling a fan or air duct plug 3. Thermistor damage 4. Working environment temperature is too high 	<ol style="list-style-type: none"> 1. Reduce the carrier frequency 2. Replace the fan or fan foreign body 3. Contact the manufacturer 4. Please send the forehead to use when working environment is higher than 40 °C
8	Abnormal communication	<ol style="list-style-type: none"> 1. The jamming signal big or wrong 	<ol style="list-style-type: none"> 1. Communication line and the circular

No.	Common phenomenon	Possible reasons for	The solution
		wiring 2. Communication parameter setting is not correct 3. Control panel fault	(shielded wire) and grounded 2. Review the communication parameters 3. Contact the manufacturer
9	External control potentiometer can't normal speed	1. Potentiometer connection errors 2. Voltage, current jump line selection error	1. Check the potentiometer wiring is correct 2. Voltage, current jump line selection for the input voltage

Chapter 7 Maintenance and maintenance

warning

- ◆ Maintenance should be professional.
- ◆ Before maintenance, must cut off the inverter power supply, maintenance work after power light extinguished.
- ◆ Maintenance personnel must according to the maintenance of the specified method.
- ◆ Maintenance personnel need to wear electrostatic ring as far as possible don't direct contact to touch on the PCB components, easy damage of static frequency converter device.
- ◆ After the completion of the maintenance, all to tighten the screws.

The VFD will be bad parts inside, even if the normal use ,if more than life ,will slao be failure.

So in order to prevent the VFD failure, Ensure the normal order of the VDF, prolong the service life of VFD, need for frequency converter regular maintenance.

7.1 Daily maintenance

Check the project	Check the content
The input power	Confirm whether the input voltage/frequency within the scope of the permit
The motor	Check for abnormal vibration motor, fever, and presence of abnormal noise and the problem of lack of phase line
Panel displays	Panel display is normal
fan	Fan operation is normal, without sundry jam, and so on and so forth
The VDF	Check whether there is any abnormal fever on frequency converter, the presence of abnormal vibration
The surrounding environment	Surrounding environment conform to the requirements of the specification, confirm there is no oil mist, dust and water coagulation in the frequency converter, etc

7.2 Regular inspection

The company regularly check table of frequency VFD as shown below. In general, to once every 3 to 6 months it is advisable to regularly check, But please combined with the actual operation of the machine and working environment, To determine the reasonable inspection frequency. Periodic inspection helps prevent damage of function of variation and the product.

In order to prevent electric shock, Please do not in the state of power on terminal operations. Otherwise there will be a risk of electric shock.

Check before, please cut off all the power of the equipment. Even if cut off the power supply, internal and residual voltage in the capacitor, for main circuit dc voltage drop below 36v, After the lights of charge indicator of VFD go out to check operation After the lights go out to check operation.

Regular inspection table

Check the project	check the content	Fault corresponding strategies	Inspectors	Check the project
The primary loop				
Overall check	Using the megohmmeter check (main circuit terminal and earthing terminal)	Contact service or the company		
	If there's any discoloration due to overheating or aging components, all parts are in damage or deformation	Contact service or the company		
	Too much dust, oil mist, etc	With dry compressed air to clean (ESD)		
The wire	Whether the power cord, motor discoloration, damage and aging due to overheating; Whether line skin breakage, cracks, discoloration, etc	Replace damaged wires		
amphenol connector	Whether the terminal for wear, damage, loose, etc	Tighten the screws or replace terminals		
Braking resistor	Whether discoloration caused by overheating of the insulator	Slight fading is normal; Faded badly, please ensure that the connection is bad or choose more powerful resistance		
Electrolytic capacitor	Whether the capacitance discharge, swelling, discoloration, cracks, etc	Repair or replace damaged parts, serious when replacing the entire frequency converter		
Diode, IGBT, rectifier bridge	Whether is stained with trash and dust, whether because of fever and poor contact	Professional welding or replacement		
Control Loop				
The whole	Whether is stained with too much dust, oil mist, etc	With dry compressed air to clean (ESD)		
	If there's any discoloration due to overheating or aging components, all parts are in deformation and damage	Repair or replace damaged parts, serious when replacing the entire inverter		
Control Panel	Whether Showing is correct、 Whether the panel dirt	When there is a bad situation of picture or operating key, please contact with the company		
Terminal	Whether the terminal for wear, damage, loose, etc	Tighten the screws or replace terminals		
Electric wire	Whether line color, damage and aging; Whether line skin breakage, cracks, discoloration, etc	Replace damaged wires		

Check the project	check the content	Fault corresponding strategies	Inspectors	Check the project
Cooling System				
fan	Whether there is abnormal sound and vibration of the motor Whether there is any damage or loss of blades	With dry compressed air to clean or replace the cooling fan		
Cooling fin	stained with trash and dust and dirt	With dry compressed air to remove rubbish and dust		
Vent hole	Inlet, outlet blockage or stained with foreign body	With dry compressed air to remove obstacles and dust		

MIKOM Electrical Technology Co.,Ltd.

Add:No.85,Dandong Road,Hi-tech Zone,Weihai,Shangdong Province

E-mail:support@mikom.com.cn

Http://www.mikom.com.cn

Technical Support :400-680-8951



All rights reserved.
The contents are subject to
change without prior notice.